



BTU900

Portable Combustion Gas Analyzers



TABLE OF CONTENTS

1.0	INTRODUCTION	05
1.1	General Description of the Combustion Analyzer	05
1.2	General features of the Combustion Gas Analyzer	05
1.3	BTU900 Main configurations	06
2.0	TECHNICAL SPECIFICATIONS	07
2.1	Technical Specifications	07
2.2	Overview of Flue Gas Analyzer Components	08
2.3	Measurement and Accuracy Ranges	11
3.0	USING THE COMBUSTION FLUE GAS ANALYZER	12
3.1	Preliminary operations	12
3.2	Warnings	12
3.3	Analyzer power supply	12
3.3.1	Checking and replacing the batteries	12
3.3.2	Use with external power pack	12
4.0	OPERATION	14
4.1	Working principle	14
4.2	Measurement cells	14
4.3	Connecting the Sampling probe	14
4.4	Condensate (water) trap and fine dust filter	14
4.5	Connecting the SMART Incoming Air temperature probe	15
4.6	Connecting the TcK probe	15
4.7	Keypad overview	16
4.8	Info Menu	17
4.8.1	Flow Chart - Info Menu	18
4.9	Analysis configuration menu	20
4.9.1	Flow Chart - Analysis configuration menu	22
4.10	Instrument configuration menu	27
4.10.1	Flow Chart - Instrument configuration menu	28
4.11	Memory Menu	30
4.11.1	Flow Chart - Memory Menu	31
4.12	Print Menu	33
4.12.1	Flow Chart - Print Menu	34
4.13	Analysis Menu	36
4.13.1	Zoom Menu	36
4.13.2	Flow Chart - Analysis Menu (Zoom)	37
4.14	Draft Menu	39
4.14.1	Flow Chart - Draft Menu	39
4.15	Readings Menu	40
4.15.1	Flow Chart - Readings Menu	41
4.16	Flow Chart - Configure Analysis Menu	42
4.17	Flue Gas Analysis	43
4.17.1	Switching on the instrument and auto-calibration	43
4.17.2	Inserting the probe inside the stack	43
4.17.3	Flue Gas Analysis	43
4.17.4	End of Analysis	44
4.17.5	Flow Chart - Flue Gas Analysis	45
4.18	Measuring the Differential Pressure (optional kit)	49

TABLE OF CONTENTS

5.0	SENSORS	50
5.1	Sensor Arrangement	50
5.2	Sensor types and relevant positioning	50
5.3	Gas sensor life	50
5.4	Gas sensor life table	50
5.5	Expandability to 3 sensors	51
6.0	MAINTENANCE	52
6.1	Routine maintenance	52
6.2	Preventive maintenance	52
6.3	Cleaning the sample probe	52
6.4	Maintaining the water trap / filter unit	52
6.5	Replacing the particulate filter	53
6.6	Replacing the gas sensors	53
6.7	On-site recalibration	57
	6.7.1 Flow Chart - On-site recalibration	57
6.8	Replacing the battery pack	60
7.0	TROUBLESHOOTING	61
7.1	Troubleshooting guide	61
8.0	SPARE PARTS AND TECHNICAL ASSISTANCE	63
8.1	Spare parts	63
8.2	Accessories	63
8.3	Service Center	63

1.0 INTRODUCTION

1.1 General Description of the Combustion Analyzer

The design of the handheld combustion analyzer "BTU900" is clean and ergonomic with an extremely clear and user-friendly keypad.

The "BTU900" immediately suggests just how even the most sophisticated engineering can give life to an incredibly comfortable and easy to use work instrument.

Devised to analyse flue gases, monitor the pollutants emitted and measure environmental parameters, "BTU900" uses two electrochemical cells that provide the oxygen and carbon monoxide values while a third cell (optional) is used to measure the pollutants NO and NOx.

Two external sensors measure the environmental parameters; it is also possible to measure flue draft and carbon black and, with the measuring range of up to 200hPa, system pressure and pressure in the combustion chamber can be measured and the pressure switches checked.

"BTU900" is designed for seven main types of combustible substances, among which natural gas, LPG, Diesel fuel and fuel oil. Another 16 types of which the chemical composition is known can be entered in its memory. "BTU900" functions include storing and averaging the measurements acquired, printing the results (through IR communication interface) and connecting to the computer for filing the data, using a USB connection.

The memory can store 300 complete analyses and the data downloaded onto a PC by means of dedicated SW and a mini-USB serial communication cable. It is also interesting to note that "BTU900" has just one "Li-Ion" rechargeable battery pack used for powering the instrument and the printer; it also has a luminous and large (42 x 60mm) LCD display boasting excellent readability thanks to its backlighting and also to the zoom function.

Another characteristic that distinguishes it from other similar products in the market is the fact the power supply that comes with the product can carry out the dual function of battery charger and power supply for the instrument which means the user can carry out analyses even if the batteries are completely flat.

As far as concerns maintenance, it is useful to know that the user can replace the sensors himself without having to send the instrument back to the technical Service center: in fact, the sensors are pre-calibrated and "BTU900" does not need recalibrating.

Moreover:

- **Operator interface:** user-friendly - so much so that it can be used without the instruction manual.
- **Luminous and large LCD display:** easy readability thanks to the Zoom function and effective backlighting.
- **Infrared interface:** optional external impact printer is available.
- **One battery pack:** rechargeable for powering the instrument and the printer, indicating the charge level and is accessible from outside.
- **Pneumatic input connectors (gas and pressure/draft) staying inside the profile of the instrument:** for greater resistance to knocks.
- **Pre-Calibrated sensors, directly replaceable by the user.**

1.2 General features of the Combustion Flue Gas Analyzer

The BTU900 is a portable flue gas analyzer that was meticulously designed to meet statutory requirements and specific customer demands. It may be provided in a rugged ABS carry case or waterproof shoulder bag.

The instrument contains one single board with all the basic circuitry, pre-calibrated measuring cells, sampling pump, silicone keypad, backlit graphic LCD display, and an high-capacity rechargeable Li-Ion battery pack. The two halves of the case are firmly secured by four screws on the rear of the instrument.

The pneumatic path and measuring cells inclusive of electronic micromodule are located on the back side of the plastic case and are easily accessed for maintenance and replacement by removing the cover carrying the functions label.

The pneumatic connectors for flue gas sampling and pressure/draft measurement as well as the flue gas thermocouple connector and the mini-DIN serial interface are installed on the lower end of the instrument.

On the left hand side there is a plug for connecting the external power supply, the 8-pin mini-DIN, the IR interface and the mini-USB connectors.

The 8-pin mini-DIN connector can be used as a serial-DIN interface or as an optional probe interface for Deprimometer or Pt100 combustion air probe.

The user interface consists of a constantly active backlit graphic LCD display and silicone keypad. Menu screens and all user messages can be set in the language of the country where it is used; this can be selected through the menu in one of the available ones. Use of the analyzer is simplified by symbol keys that give direct access to main instrument functions. Shifting between the various menu screens is easy and user-friendly thanks to four cursor keys, an ' **ok** ' key and ' **esc** ' key.

1

1.3 BTU900 Main configurations

	BTU900 - HE	BTU900 - Oil	BTU900 - NOx	BTU900 - HE-NOx
O ₂ SENSOR	✓	✓	✓	✓
CO (Low H ₂) SENSOR	✓	✓	✓	✓
NO SENSOR	Optional	Optional	✓	✓
BLUETOOTH	✓	✓	✓	✓
CALIBRATION CERTIFICATE	✓	✓	✓	✓
INSTRUCTION MANUAL	✓	✓	✓	✓
FLUE SAMPLING PROBE 300mm (12") + 10' Dual Hose	✓	✓	✓	✓
SMART INCOMING COMBUSTION AIR TEMPERATURE PROBE	✓	Optional	Optional	✓
WATER TRAP	✓	✓	✓	✓
SMOKE PUMP KIT	Optional	✓	Optional	Optional
PRESSURE MANOMETER	✓	✓	✓	✓
BATTERY CHARGER	✓	✓	✓	✓
BATTERY CHARGER CABLE, US PLUG	✓	✓	✓	✓
MEMORY + PC SOFTWARE	✓	✓	✓	✓
HARD CASE	✓	✓	✓	✓

2

3

4

5

6

7

8

2.0 TECHNICAL SPECIFICATIONS

2.1 Technical Specifications

Autozero:	Manual autozero cycle (without probe inserted in the stack).
Self-diagnosis:	All the functions and internal functions are checked and anomalies signalled.
Type of Fuels/Oils:	7 predefined by the factory and 16 that can be programmed by the user.
Power:	Li-Ion battery pack with internal protection circuit.
Battery charger:	External battery charger.
Battery autonomy:	12 hours of continuous operation from fully charged battery.
Charging time:	4 hours for charging from 0% to 90% (5 hours for 100% charge).
Internal data memory:	300 complete data analysis, time and name of the customer can be stored.
User data:	3 programmable user names.
Print-out heading:	4 lines x 24 characters, customisable by the user.
Display:	Graphic backlit LCD, measuring 42 x 60 mm.
Communication port:	USB with mini-USB connector. IR interface for external printer using HP-IR protocol (optional).
Bluetooth (optional):	Communication range: <100 meters (free field) Manufacturer: FREE2MOVE Model: F2M03GLA - CLASS 1 Bluetooth SIG Qualification Design (QDL) Certificate: B012541 Certification EC-R & TTE: C0681
Line filter:	With replaceable cartridge, 99% efficient with 20um particles.
Suction pump:	1.2 l/min heads at the flue up to 135hPa.
Condensate trap:	Outside the instrument.
Carbon black:	Using an optional external Smoke hand pump; it is possible to simply enter and print the Smoke index results.
Condensing boiler efficiency:	Automatic recognition of the condensing boiler, with calculation and printout of efficiency (>100%) on the LHV (Lower Heating Value) in accordance with UNI10389-1.
Environmental gases:	Measurement and separate printout of the ambient CO and NO values.
Draft test:	Draft tested as per the UNI 10845 standard. Using the external draft gauge AACDP02 the resolution is 0.1 Pa with 0.5 Pa accuracy.
Operating temperature range:	-5°C to +45°C (23°F to 113°F)
Storage temperature range:	-20°C to +50°C (-4°F to 122°F)
Operating humidity range:	20% to 80% RH
Protection grade:	IP42
Air pressure:	Atmospheric
Outer dimensions: Analyzer:	220 x 100 x 52 mm (H x W x D) 8.6 x 3.9 x 2 inches (H x W x D)
Case:	225 x 109 x 69.5 mm (H x W x D) 8.8 x 4.3 x 2.7 inches (H x W x D)
Weight: Analyzer:	~ 19.4 oz

Compliant with the CEI-EN 50379-2 European Standard.

External IR printer (optional):

- With thermal paper, 24 characters, data transmission through IR interface and HPir standard protocol.
- Paper roll size: 58mm x 40mm (paper length 25 meters, about 120 report tickets).
- Power supply: with internal rechargeable Ni-MH batteries.
- External battery charger provided with printer.

2.2 Overview of Flue Gas Analyzer Components

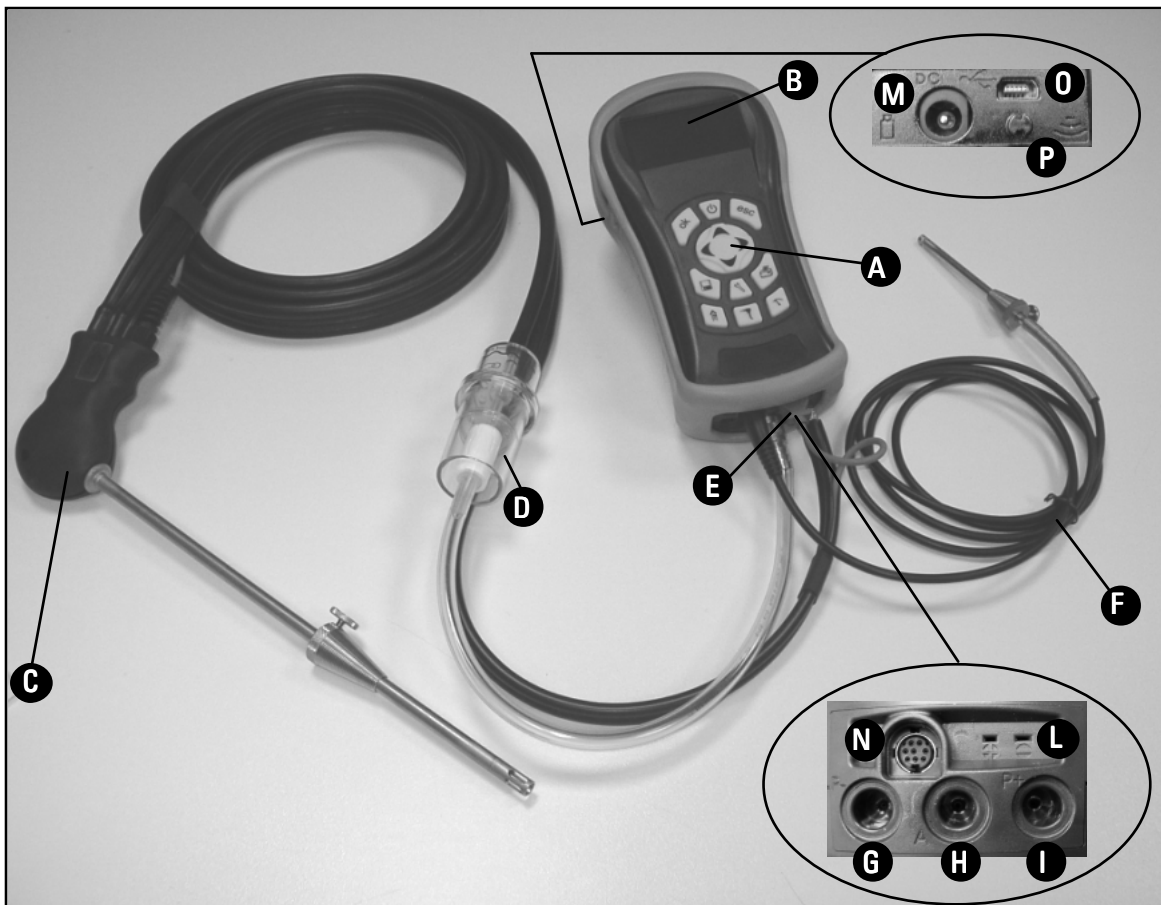

Fig. 2.2

LEGEND

- A** Keypad
- B** Display
- C** Flue Gas Sampling probe
- D** Condensate separator and fine dust filter unit (Water Trap Assembly)
- E** Compensated male connector of the fumes exhaust temperature probe
- F** SMART Incoming Air temperature probe
- G** P- connector (negative input for measuring differential pressure)
- H** A - connector (sample probe input by means of the water trap)
- I** P+ connector (positive input for measuring draft)
- L** Temperature Tc-K female connector
- M** Battery charger socket
- N** Serial cable socket for connecting to the draft gauge and to the ancillary probes
- O** Mini-USB socket for connecting to a PC
- P** IR communication port

Keypad

Silicone rubber keypad featuring main control functions (pos. **A** in Fig. 2.2).

Display

Backlit 128 x 64 pixel LCD display (pos. **B** in Fig. 2.2), with 8 lines x 20 characters available. Allows the user to view the measured parameters in the most comfortable format; a Zoom function displays the measured values in magnified form.

CAUTION: If the instrument is exposed to extremely high or extremely low temperatures, the quality of the display may be temporarily impaired. Display appearance may be improved by acting on the contrast key.

Rechargeable Battery Pack

The instrument is provided with a 12VDC, 2A power supply pack to charge the internal batteries.

The socket for connecting the battery charger to the instrument is shown as item **M** in Fig. 2.2. Once the charge is started the display turns on and shows the charge status.

Serial connector (Mini Din 8-pole)

In **N** of Fig.2.2 we find the socket of the serial cable for connecting the instrument to an external probe, for example, to the draft gauge (optional), or to the ionization current probe (optional).

Mini/USB connector

In **O** of Fig.2.2 we find the socket of the serial cable for connecting the instrument to a personal computer.

Sample pump

The sample pump located inside the instrument is a DC-motor-driven diaphragm pump, powered by the instrument, and is such as to obtain optimal flow of the sampled gas being analyzed.

Flue Gas Sampling Probe

Stainless steel probe with plastic handgrip (see **C** of Fig.2.2). The Standard Length of the steel probes is 12 inches (300 mm). Other available lengths are 180 mm, 750 mm and 1000 mm with adapter cone for the flue hole, diameter 8-22 mm. A flexible probe is also available with a 300 mm long tip, for measuring inside flues where the fumes picking point is difficult to reach. All probes have a nominal outside diameter of 8 mm.

Connection to an analyzer via a 3-meter rubber hose and replaceable condensate separator and fine dust filter unit (see **D** of Fig.2.2).

Measurement Cells

The instrument uses pre-calibrated gas sensors of the long-lasting FLEX-Sensor series for measuring oxygen (O₂), carbon monoxide CO and nitrogen oxide (NO). Up to 4 alarms can be programmed with visual and acoustic warning for the same number of measuring parameters.

The measuring cells are the electrochemical type. The UNI 10389-1 standard prescribes that the instrument must be calibrated once a year by an authorized laboratory to issue calibration certificates. When the cells are flat they can be replaced easily by the user without having to send the instrument away and without complicated calibration procedures requiring sample mixtures as they are supplied already calibrated.

E Instruments does, however, certify measurement accuracy only when a calibration certificate has been issued by its own laboratory or by an authorized laboratory.

Temperature sensors

Flue gas temperature is measured by means of a thermocouple inserted in the tip of the probe.

The thermocouple is connected to the instrument via a compensated cable (pos. **E** in Fig. 2.2.) housed in a special seating in the rubber hose of the sample probe.

Connection to the instrument is achieved via a temperature-compensated male connector.

The cold junction is compensated by a Pt 100 resistance thermometer which measures the temperature at the thermocouple connector.

The type K thermocouple (nickel/nickel chromium) permits continuous measurements up to 800°C. If special-purpose probes are used, the instrument is able to measure temperatures as high as 999.9°C.

A Pt 100 resistance thermometer located inside the instrument measures the internal temperature; this sensor is also used to measure the ambient temperature.

Should the user want to measure the combustion air temperature directly in the intake duct, the optional remote Pt 100 sensor must be used - this measurement is recommended for more precise calculation of plant efficiency.

Remote temperature probe

The temperature probe consists of a Pt 100 probe, complete with 2 m cable and 7.5/17 mm pit adapter (pos. **F**

in Fig. 2.2). This probe is used to measure the combustion air temperature, within a range of -10°C to +100°C, when boiler efficiency is to be calculated precisely.

Pressure sensor

The instrument features an internal piezoresistive sensor to measure the stack draft (negative pressure) and other parameters if required (gas network pressure, pressure drop across filters etc.). The user can switch from flue gas analysis to this reading by simply pressing a key.

Sample and +/- pressure inputs

The positive input P+ and negative input P- are used simultaneously to measure differential pressure. Pos. **H** in Fig. 2.2 is the input of the sample probe complete with water separator and particulate filter. Pos. **I** and **G** in Fig. 2.2 are respectively the positive and negative internal differential pressure sensor inputs. The positive input P+ **I** is used to measure pressure in general. The positive input P+ **I** is used to measure draft in accordance with standard UNI10845; the branch of the fume exhaust probe without the anti-condensation filter should be connected to it for simultaneous draft measurement and combustion analysis.

Fuel types

The instrument has been programmed with the technical characteristics that are typical of seven common fuels. By means of the optional PC configuration program, this list and the relative coefficients may be modified for up to a total of 10 fuels.

The following chart, derived from standard UNI 10389-1, lists the coefficients of the seven memorized fuels, used for calculating losses and efficiencies.

Coefficients for calculating combustion efficiency				
A1	A2	B	CO ₂ t %	Fuel
0,280	0,3276	0,0090	11,70	Natural gas
0,0305	0,4789	0,0066	15,70	#2 Oil
0,0306	0,4835	0,0066	15,80	#4 Oil
0,0305	0,4789	0,0066	15,70	Diesel
0,0354	0,6700	0,0071	19,01	Wood/Pellets 8%
0,0320	0,5952	0,0000	18,60	Coal
0,0305	0,4789	0,0066	15,70	Bio-Fuel 5%
0,0277	0,4500	0,0073	13,80	LPG
0,0277	0,3795	0,0073	14,00	Butane
0,0277	0,3878	0,0073	13,70	Propane

Smoke measurements

It is possible to enter the smoke values measured according to the standard Smoke index scale. The instrument will calculate the average and print the results in the analysis report.

An external smoke pump, available as an optional, must be used to correctly take this measurement.

Measuring ambient /room air CO (Carbon Monoxide)

Probe for monitoring the concentration of CO and checking safe conditions in the boiler room. An acoustic and visual warning signal is given if the thresholds are exceeded according to the OSHA levels.

Internal gas leak detector sensor

This sensor searches for explosive gas leaks in the pipes.

External low pressure sensor (draft gauge)

This sensor is a particular draft gauge with precision (± 0.5 Pa) and resolution (0.1 Pa) characteristics higher than those of the sensor installed inside the instrument. This makes it possible to comply with the UNI 10845 standard.

Burner pressure verification probe

It must be used to measure burner pressure of the gas-powered boiler so it can be regulated in real time. It is made of a silicone tube, 8x4mm and 1 metre long, complete with connector for connecting to the analyzer.

Probe for measuring the ionization current

With this special probe it is possible to measure the ionization current of a boiler and check its value depending on the boiler's technical features.

Calibration certificate

The instrument is calibrated by comparing to National Calibration Standards provided by a Metrology Lab., certified periodically by internationally recognized laboratories.

A calibration certificate is provided with each and every instrument where every parameter is accompanied by the relevant nominal value, measured value, permissible error tolerances and measured error.

Electromagnetic compatibility

The instrument was designed to comply with Council Directive 2004/108/EC governing electromagnetic compatibility.

2.3 Measurement Ranges and Accuracies

MEASUREMENT	SENSOR	RANGE	RESOLUTION	ACCURACY	
O ₂	Electrochemical sensor	0 .. 25.0% vol	0.1% vol	±0.2% vol	
CO With low sensitivity to H ₂	Electrochemical sensor	0 .. 8000 ppm	1 ppm	±20 ppm ±5% measured value ±10% measured value	0 .. 400 ppm 201 .. 4000 ppm 4001 .. 8000 ppm
NO	Electrochemical sensor	0 .. 5000 ppm	1 ppm	±5 ppm ±5% measured value	0 .. 100 ppm 101 .. 5000 ppm
NO _x	Calculated				
CO ₂	Calculated	0 .. 99.9% vol (1)	0.1% vol		
Air temperature	Pt100 sensor	-20.0 .. 120.0 °C	0.1 °C	±0.5 °C (2)	
Flue gas temperature	TcK sensor	-100.0 .. 1250.0 °C	0.1 °C	±0.5 °C ±0.5% measured value	0 .. 10 °C 101 .. 1250 °C (3)
Pressure (draft & differential)	Piezoelectric sensor	-4.014 .. 80.292 inH ₂ O (4)	0.004 inH ₂ O	±1% measured value ±0.008 inH ₂ O ±1% measured value	-4.014 .. 0.806 inH ₂ O -0.802 .. 0.802 inH ₂ O 0.806 .. 0.292 inH ₂ O
Differential temperature	Calculated	0 .. 1250.0 °C	0.1 °C		
Air index	Calculated	0.00 .. 9.50	0.01		
Excess air	Calculated	0 .. 850 %	1 %		
Stack loss	Calculated	0.0 .. 100.0 %	0.1 %		
Efficiency	Calculated	0.0 .. 100.0 %	0.1 %		
Efficiency (condensing)	Calculated	0.0 .. 120.0 %	0.1 %		
Smoke index	External instrument	0 .. 9			

All data relative to concentration accuracies are referred to an instrument operating at a constant temperature within the correct operating range (-5°C .. +45°C), being in operation for at least 15 minutes, powered by its internal battery and after completion of auto-zero procedure.

- Notes:** (1) The maximum CO₂ value displayed depends on the type of fuel.
 (2) Stated precision includes error of the external sensor RTD Pt100 class A DIN 43760 (1980).
 (3) Stated precision includes error of the external sensor type K thermocouple class 1 IEC584.
 (4) Pressures greater than 300 inH₂O may permanently damage sensors or impair their characteristics.

3.0 USING THE FLUE GAS ANALYZER

3.1 Preliminary operations

Remove the instrument from its packing and check it for damage. Make sure that the content corresponds to the items ordered. If signs of tampering or damage are noticed, notify the E Instruments service center or agent immediately and keep the original packing. A label at the rear of the analyzer bears the serial number. This serial number should always be stated when requesting technical assistance, spare parts or clarification on the product or its use.

E Instruments maintains an updated database for each and every instrument.

Before using the instrument for the first time it is recommended to charge the battery for 12 hours with the instrument turned off.

3.2 Warnings

- Use the instrument with an ambient temperature between -5 and +45°C.
- When it has finished being used, before turning the instrument off remove the probe and let it aspirate ambient clean air for at least 30 seconds to purge the pneumatic path from all traces of fumes.
- Do not use the instrument if the filters are clogged or damp.
- Before putting the measuring probe back in its case after use, make sure it has cooled down enough and there is no condensate in the tube. It might be necessary to periodically disconnect the filter and the condensate separator and blow compressed air inside the tube to remove all residues.
- Remember to have the instrument checked and calibrated once a year in order to comply with the existing standards.

ATTENTION

IF THE INSTRUMENT HAS BEEN KEPT AT VERY LOW TEMPERATURES (BELOW OPERATING TEMPERATURES) WE SUGGEST WAITING A WHILE (1 HOUR) BEFORE SWITCHING IT ON TO HELP THE SYSTEM'S THERMAL BALANCE AND TO PREVENT CONDENSATE FORMING IN THE PNEUMATIC CIRCUIT.

3.3 Analyzer power supply

The instrument contains a high-capacity LiIon rechargeable battery.

The battery feeds the instrument any other probes or remote devices that may be connected. The instrument runs for approximately 18 hours. Should the battery be too low to effect the necessary measurements, the instrument can be hooked up to the mains via the power pack provided, allowing operations (and analysis) to proceed. The battery will be recharged whilst the instrument is being used.

The battery charging cycle takes up to 3 hours for a complete charge and finishes automatically.

ATTENTION: If the instrument is not going to be used for a long time we suggest recharging it at least once every 2 months.

3.3.1 Checking and replacing the batteries

The status of the internal battery can be checked during instrument auto-calibration or even after, if necessary, by pressing the information menu  and accessing the "battery capacity" submenu. The menu displays the battery's residual capacity and voltage. If battery charge appears to be low, let it discharge completely and then carry out a full 100% charge cycle by connecting the instrument to the power pack for 3 hours. If the problem persists, replace the battery pack with a E Instruments original or contact the SERVICE CENTER to carry out the necessary repairs.

The average life of the battery pack is 500 charging/discharging cycles. To take advantage of this to the fullest capability it is advisable to always use the instrument powered by the internal batteries and to charge it only when it gives the battery flat message.

ATTENTION

THE INSTRUMENT IS SHIPPED WITH THE BATTERY HALF CHARGED SO IT IS ADVISABLE TO CHARGE IT COMPLETELY BEFORE USE, TAKING 3 HOURS.

IT IS ADVISABLE TO CHARGE THE BATTERY AT AN AMBIENT TEMPERATURE RANGING BETWEEN 50°F AND 85°F (10°C AND 30°C).

3.3.2 Use with external power pack

The instrument can work with the batteries fully discharged by connecting the external power pack provided.

Kindly note that while the battery is charging, some heat is generated which increases the instrument's internal temperature. This may lower the accuracy of some readings. The air temperature must be measured using the air temperature probe since the internal sensor might lie at a different temperature with respect to ambient.

ATTENTION

THE POWER SUPPLY/BATTERY CHARGER IS A SWITCHING TYPE ONE.

THE APPLICABLE INPUT VOLTAGE RANGES BETWEEN 90Vac AND 264Vac.

INPUT FREQUENCY: 50-60Hz.

THE LOW VOLTAGE OUTPUT IS 12 VOLT WITH AN OUTPUT CURRENT GREATER THAN 1.5A.

LOW VOLTAGE SUPPLY CONNECTOR: DC PLUG 2.1x5.5x9 mm. WITH CENTRAL POSITIVE AND OUTER BARREL GROUND.

IF AN UNSUITABLE POWER SUPPLY IS CONNECTED IT CAN DAMAGE THE INSTRUMENT; USE ONLY THE ONE SUPPLIED WITH IT.

1

2

3

4

5

6

7

8

4.0 OPERATION

4.1 Working principle

The gas sample is taken in through the sample probe, by a diaphragm suction pump inside the instrument.

The measuring probe has a sliding cone that allows the probe to be inserted in holes with a diameter of 11 mm to 16 mm and to adjust the immersion depth: **the sampling point must be roughly in the center of the flue pipe/stack.**

The gas sample is cleaned of humidity and impurities by a condensate trap and filter positioned along the rubber hose that connects the probe to the analyzer.

The gas components are then analyzed by the electrochemical sensors.

Oxygen (%O₂) is measured with an electrochemical cell that acts like a battery which, over time, is apt to lose sensitivity.

The toxic gases (CO, NO) are measured with electrochemical sensors that are not subject to natural deterioration being intrinsically lacking of oxidation processes.

The electrochemical cell guarantees high precision results in a time interval of up to about 60 minutes during which the instrument can be considered very stable. When measurement is going to take a long time, we suggest auto-zeroing the instrument again and flushing the inside of the pneumatic circuit for three minutes with clean air.

During the zero calibrating phase, the instrument aspirates clean air from the environment and detects the cells' drifts from zero (20.95% for the O₂ cell), then compares them with the programmed values and compensates them. The pressure sensor autozero must, in all cases, be done manually prior to measuring pressure.

The values measured and calculated by the microprocessor are viewed on the LCD display which is backlit to ensure easy reading even when lighting is poor.

4.2 Measurement cells

The measurement cells are electrochemical cells made up of an anode, a cathode, and an electrolytic solution, which depends on the type of gas to be analyzed. The gas penetrates the cell through a selective diffusion membrane and generates an electric current proportional to the absorbed gas. Such current is measured, digitalized, temperature-compensated, processed by the microprocessor, and displayed.

The gas shall not be at a pressure such to damage or destroy sensors. The maximum estimated allowed pressure is ± 100 hPa gage.

The response times of the measurement cells used in the analyzer are:

O₂ = 50 sec. at 90% of the measured value

CO = 60 sec. at 90% of the measured value

NO = 40 sec. at 90% of the measured value

It is therefore suggested to wait 5 minutes (anyway not less than 3 minutes) in order to get reliable analysis data.

If sensors of poison gases are submitted to concentrations higher than 50% of their measurement range for more than 10 minutes continuously, they can show up to $\pm 2\%$ drift as well as a longer time to return to zero. In this case, before turning off the analyzer, it is advisable to wait for the measured value be lower than 20ppm by disconnecting the probe and letting the pump run in clean air.

4.3 Connecting the sample probe

The sampling probe is made up of an INOX steel tube with a plastic hand grip and an internal K-type thermocouple (Ni-NiCr) for measuring the fumes temperature up to 800°C. The probe is connected to the analyzer through a double flexible hose, a filter group and a compensated cable for the thermocouple. The polarized connector of the thermocouple is to be connected to the special outlet on the lower side of the instrument. It is not possible to perform a wrong connection thanks to the different width of contacts. Connect the shorter tube of the probe to the filter group (fine dust/condensate trap) which, in turn, shall be connected to the central connector of the instrument marked with letter "A". Connect the longer tube, ending with a male connector, to the negative pressure input of the instrument marked with letter "P-". The different diameter of connectors does not permit any wrong connections; this permits to avoid any damages to the instrument.

4.4 Condensate trap and fine dust filter

The sample gas to be analyzed shall reach the measurement cells after being properly dehumidified and purified from the residual combustion products. To this purpose, a condensate trap is used, which consists of a transparent polycarbonate cylinder placed along the rubber hose of the sampling probe. Its purpose is to decrease the air speed so that the heavier fine dust particles can precipitate and the vapor in the combustion gases can condensate.

The condensate trap must be always kept in the vertical position in order to prevent condensate from touching the measurement cells. This is also the reason why it is important to periodically drain the trap, anyhow at the end of each test (see chapter 'MAINTENANCE').

A replaceable low-porosity line filter is placed after the condensate trap aimed at keeping the solid particles suspended in the gases. It is recommended to replace the filter whenever visibly dirty (see chapter 'MAINTENANCE').

ATTENTION

KEEP THE CONDENSATE TRAP IN THE VERTICAL POSITION DURING THE ANALYSIS; A WRONG POSITIONING MAY CAUSE CONDENSATE TO LEAK INTO IN THE INSTRUMENT AND DAMAGE SENSORS.

AFTER EACH ANALYSIS, CHECK FOR ANY PRESENCE OF WATER IN THE CONDENSATE COLLECTION BOWL AND REMOVE IT, IF ANY. PUT THE PROBE BACK IN THE CASE ONLY AFTER YOU HAVE REMOVED CONDENSATE FROM THE TUBE AND THE EXPANSION TANK (SEE CHAPTER 'MAINTENANCE').

REPLACE THE FINE DUST FILTER IF IT IS VISIBLY DIRTY OR WET (SEE CHAPTER 'MAINTENANCE')

DO NOT PERFORM ANY MEASUREMENT WHEN THE FILTER IS REMOVED OR DIRTY IN ORDER TO AVOID ANY RISK OF PERMANENT DAMAGES ON SENSORS.

4.5 Connecting the combustion air temperature probe

Should you need to measure the actual **combustion air temperature** and the analyzer is not in the place where the combustion air is to be taken (important for a correct calculation of the burner efficiency), you shall use the remote probe.

The remote probe is made up of a Pt100 thermal resistance equipped with cable (3 meters long) and connector for its connection to the analyzer.

4.6 Connecting the TcK probe

Using the same input as for the K thermocouple (the same used for flue temperature), it is possible to measure the water delivery and return temperature by connecting some **special probes**. If temperature is taken on the pipe, it is suggested to use arc probes with a suitable diameter.

1
2
3
4
5
6
7
8

4.7 Keypad overview

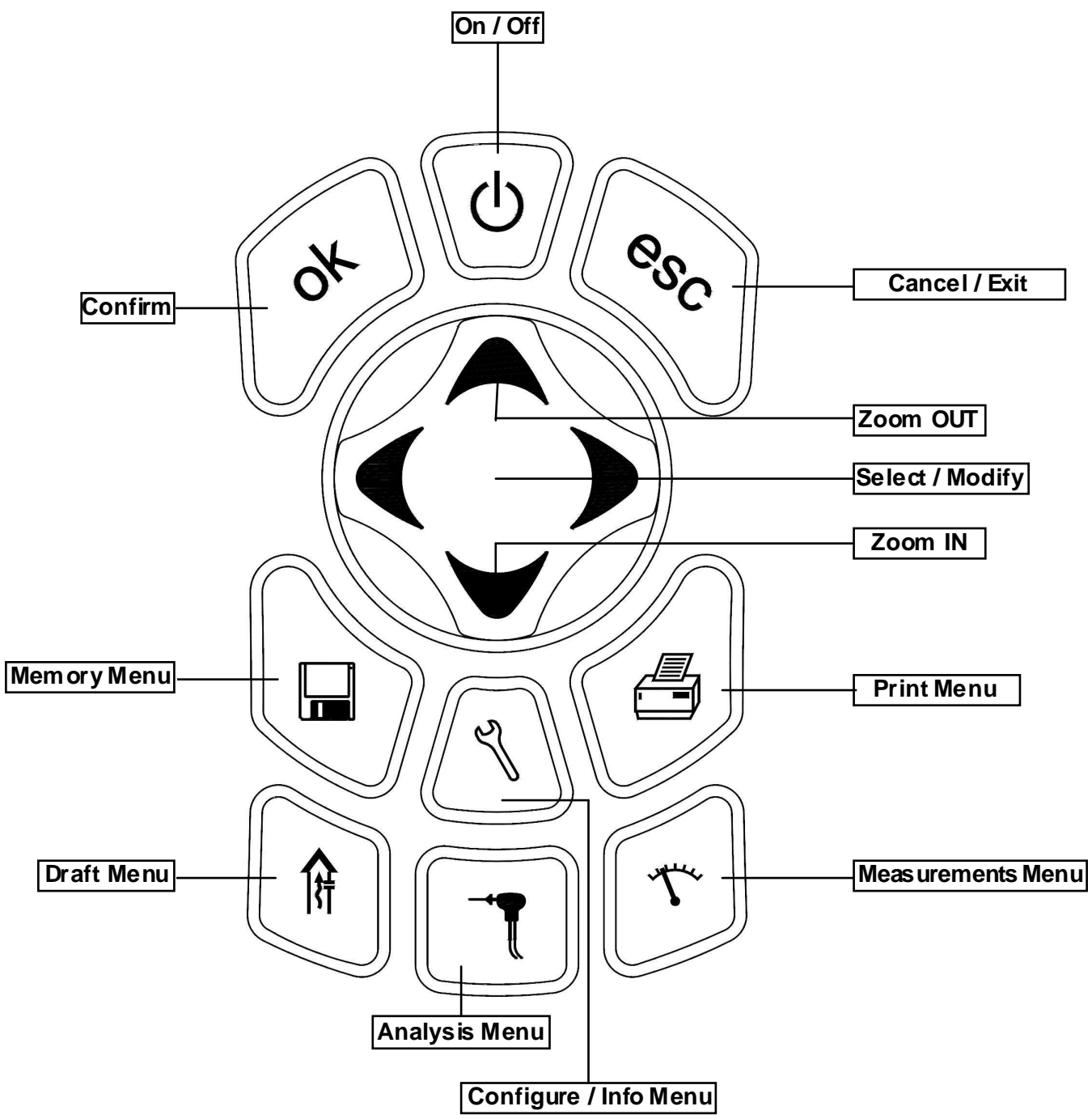

WARNING: to turn-on / off the instrument it is necessary to press and hold the On/Off button for at least 2 seconds.



4.8 Info Menu

This menu provides information regarding instrument status:

Battery capacity:

Shows the status of the internal battery.

The battery charge status is shown graphically and in text as a percentage between 0 and 100%, together with the battery voltage.

Configuration of sensors:

It allows to check which sensors are installed on the instrument, and in which position they are installed. The instrument automatically detects whether a sensor has been either added or removed. The screen page allows whether to accept the new configuration or ignore the change performed.

Sensor diagnostics:

This feature displays useful information about the status as well as about the calibration of the internal electrochemical sensors. Through this screen the user can access the data that fully identify the sensor, such as: sensor type, serial number, manufacturing and calibration dates. In addition to this are also shown the current values generated by the sensors thus allowing for a quick troubleshooting in case of issues referable to the sensors.

Gas path check

Tests the tightness of the gas probe pneumatic path.

Memories diagnostics:

At instrument turn on the firmware performs a full check on the physical efficiency of all types of HW memories installed on the instrument, as well as on the integrity of the data stored into them. Any issue is evidenced in the screen 'Memories Diagnostics'. Should this happen it is advisable to turn the instrument off and then on again. In case the problem is permanent or frequently recurring, the user should contact the Service Center reporting the error code shown by the instrument.

Info service:

This submenu contains details regarding the nearest Service Center to be contacted in the event of instrument fault or ordinary maintenance. The instrument model, serial number and firmware version are also displayed, thus allowing for a quick product identification.

External probe:

Shows useful information about the probe connected to connector **O** Fig. 2.2 on page 8.

The Flow Chart in the following page shows how to browse through the Info Menu screens.

1
2
3
4
5
6
7
8

4.8.1 Flow Chart - Info Menu



Activates the Info Menu.

To return to the previous screen, press **esc**

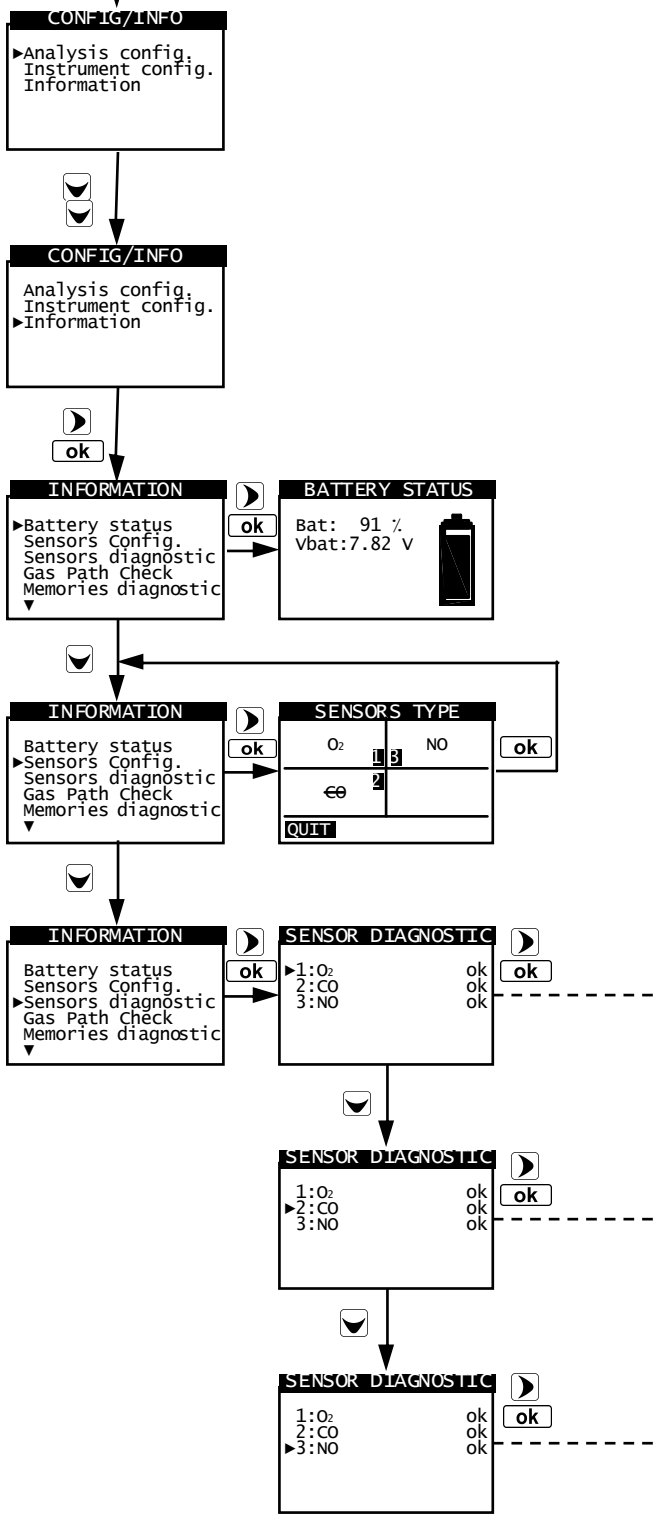

The battery symbol filling up means that battery charging is ongoing.

This screen page shows, for each position, the following messages (example referred to the sensor in position 2):
CO Sensor configured OK
☐→CO Sensor missing or non communicating
CO→☐ New sensor detected
☐☐ Sensor detected in a wrong position

Use arrows to scroll the parameters of each selected cell. Here below are the data which can be displayed through the sensors troubleshooting menu:

- Type:** Type of sensor
- Revision:** Sensor revision index
- Date code:** Production batch
- Gas:** Gas measured
- Serial:** Sensor serial number
- Manufacturing date:** Production date
- Calibration date:** Calibration date
- Is:** Sensor Is current
- Ia:** Sensor Ia current

Furthermore, under sensor troubleshooting mode, the instrument can display the status of each single cell (here is an example) visualized after the visualization of the measured gas:

- Ok:** No problem detected
- missing** The sensor has not been detected
- data err** Sensor memory data error
- Unknown** The instrument FW needs to be updated
- pos err** Sensor installed in the wrong position
- cal err** Calibration error
- curr err** Currents out of range
- non config** This sensor is not to be used because it has not been accepted in the page 'type of sensor'.



1

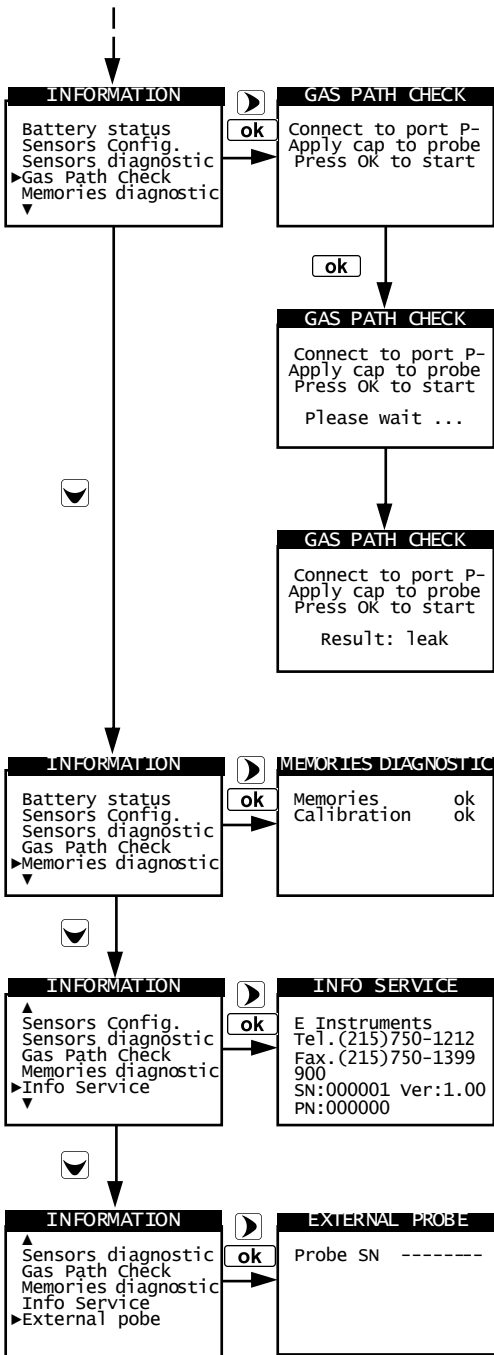

Connect the flue gas sampling probe and filter unit assembly to the instrument;
Fully insert the black rubber cap on the gas probe tip, as shown in the following picture:

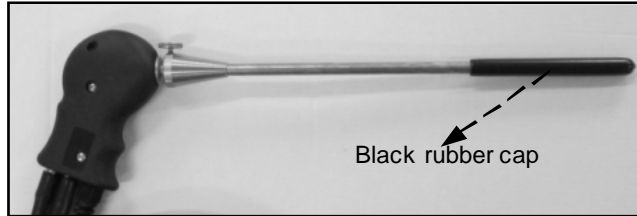

2

3

4

5

6

7

8

4.9 Analysis configuration menu



Through this menu the user can configure the available parameters for a proper combustion analysis.

Fuel:

Lets the user select the type of fuel to be used during analysis. This data can be changed either from this menu or during the analysis itself.

Measurement units:

Through this submenu the user can modify the units of measurement for all the analysis parameters, depending on how they are used.

O2 Reference:

In this mode the user can set the oxygen percentage level that pollutant emission values are corrected to for that given O2 reference level.

Automatic analysis:

The user can set analysis mode to either manual or automatic.

In manual mode the user performs the three necessary analysis operations manually. In automatic mode the cycle duration for each reading must also be set - in this case the instrument will conduct each analysis in the specified time.

Printing may also be manual or automatic. If "auto" printing is selected, the instrument will automatically print the analysis report in a predetermined format at the end of the automatic analysis.

Condensation

The burner efficiency figure when condensation takes place is influenced by atmospheric pressure and humidity of the combustion air.

As the atmospheric pressure is hardly precisely known, the operator is asked to enter a related parameter, i.e. the altitude of the place above the sea level, from which the pressure is then derived once the dependency from atmospheric conditions is neglected. In calculations the value of 101325 Pa is assumed as atmospheric pressure at sea level.

Further the air relative humidity input is allowed, being this calculated at the combustion air temperature as measured from the instrument; in case this value is unknown the operator is recommended to enter 50% for this value.

NOx/NO Factor

NOx/NO: all the nitrogen oxides which are present in the flue emissions (Nitrogen oxide = NO)

In the combustion processes, it is found out that the NO₂ percentage contained in the flue gas are typically not far from very low values (3%); hence it is possible to obtain the NO_x value by a simple calculation without using a direct measurement with a further NO₂ sensor.

The NO₂ percentage value contained in the fumes can be however set at a value other than 3% (default value).

Alarms:

This submenu allows the user to set and memorise 5 alarms, defining the monitored parameter for each, the alarm threshold and relative unit of measurement and whether it is a low or high-level alarm.

Low-level alarms are triggered when the reading drops below the defined threshold, whereas high-level alarms are triggered when the reading rises above the defined threshold.

When an alarm threshold is crossed, the instrument emits an intermittent audible alarm besides activating a visible alarm wherein the background of the name of the relative reading will start flashing in the analysis screen.

When the CO and NO concentration thresholds are crossed, besides activating the audible and visible alarms, the CO and NO solenoid valves may also be set to intervene and thereby interrupt sample flow.

If the instrument is not fitted with a solenoid valve, the sample pump will in any case be stopped.

Autozero/Pump:

This submenu is used to set the duration of the analyzer auto-calibration cycle. It may also be used to switch off or switch on the sample pump temporarily. The sample pump cannot be switched off if the auto-calibration cycle is under way.

Operator:

The name of the operator conducting the analysis may be set or modified through this submenu. A maximum of



three names may be stored. The name of the selected operator will be printed on the analysis report.

Report header setup:

This allows the Company or Owner's name to be entered in four lines with 24 characters each, together with other details (e.g. address, tel. no., email). This data will be printed on the heading of the analysis report.

1

2

3

4

5

6

7

8



1

2

3

4

5

6

7

8

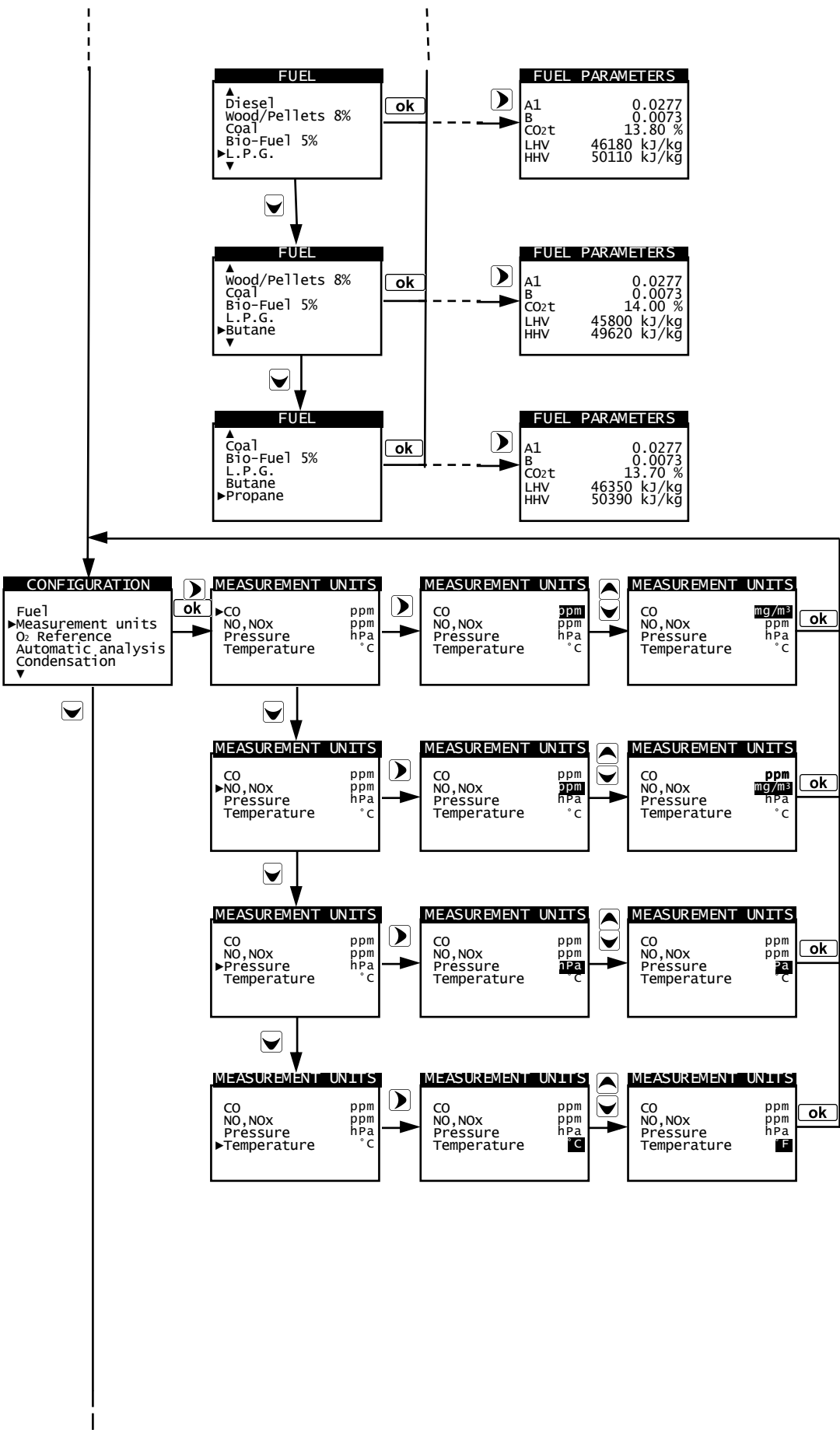

Measurement unit can be set as:
 ppm - mg/m³ -
 mg/kWh - g/GJ -
 g/m³ - g/kWh - %

Measurement unit can be set as:
 ppm - mg/m³ -
 mg/kWh - g/GJ -
 g/m³ - g/kWh - %

Measurement unit can be set as:
 hPa - Pa - mbar -
 mmH₂O - mmHg -
 inH₂O - psi

Measurement unit can be set as:
 °C - °F

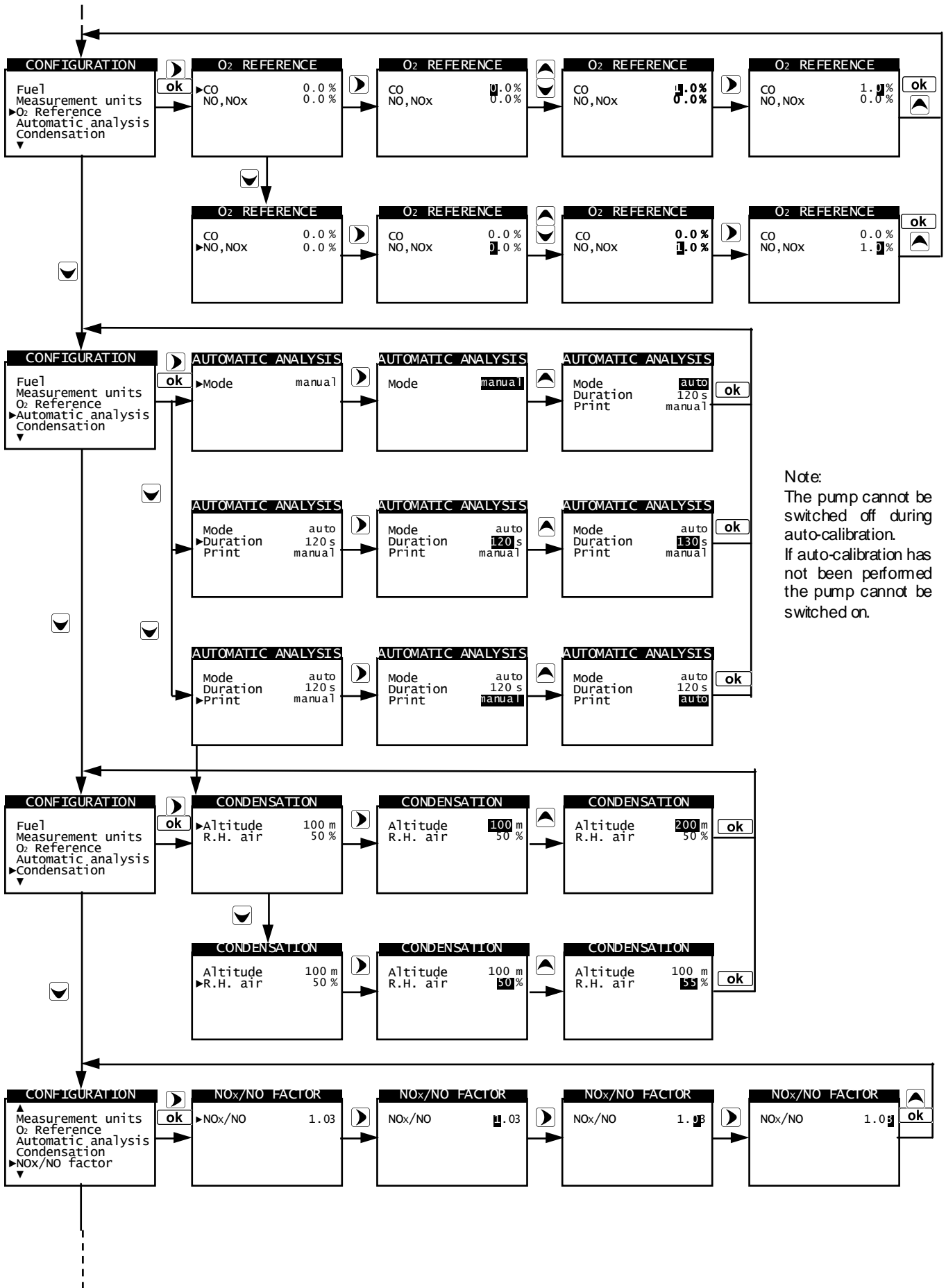

Note:
The pump cannot be switched off during auto-calibration. If auto-calibration has not been performed the pump cannot be switched on.



1

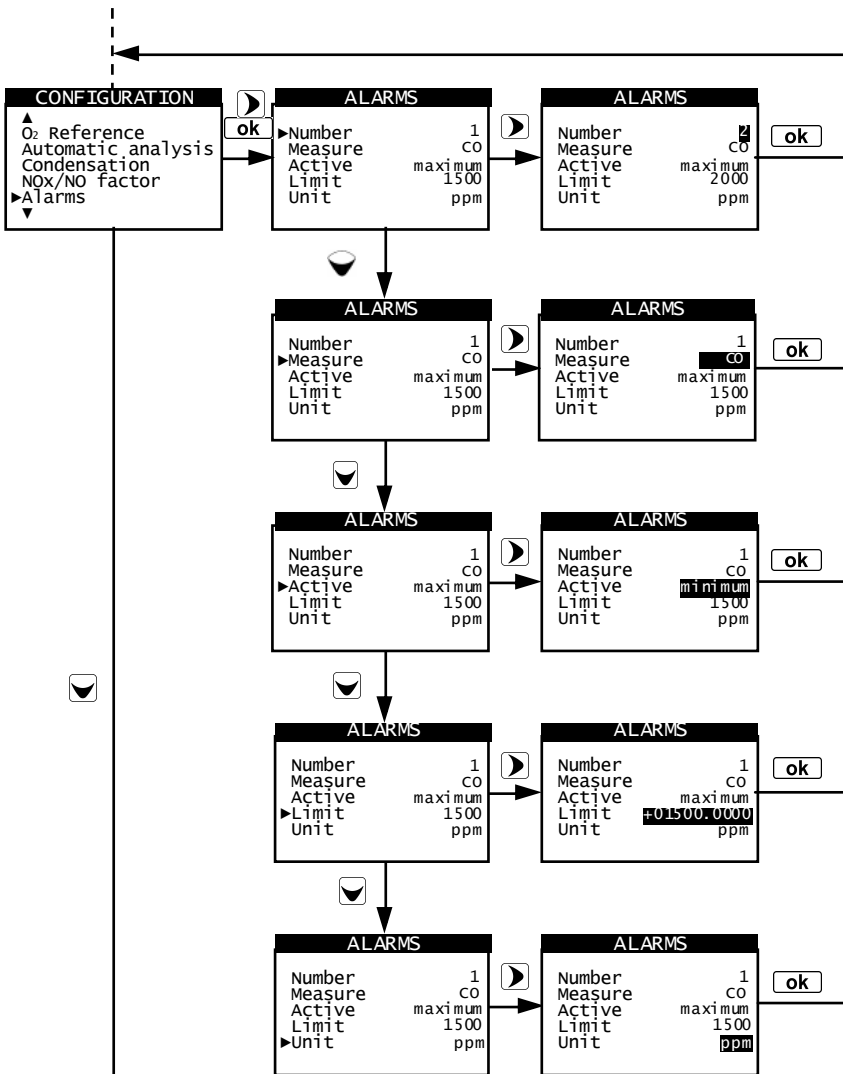

Modify the value of the highlighted figure with keys \leftarrow \rightarrow .

Select alarm number (1÷5) with the keys \downarrow \uparrow .

The values that can be selected with the \downarrow \uparrow keys for this parameter are:

O₂, CO, NO, P, Tf, Ta

The values that can be selected with the \downarrow \uparrow keys for this parameter are:

maximum, minimum, no

The alarm threshold values can be set via the \downarrow \uparrow keys within the following range:

- 99999.999 to + 99999.99

(the value is referred to the unit of measurement set) maximum, minimum, no.

The values that can be selected with the \downarrow \uparrow keys for this parameter are:

ppm, mg/m³, mg/kWh, g/GJ, g/m³, g/kWh, %

2

3

4

5

6

7

8

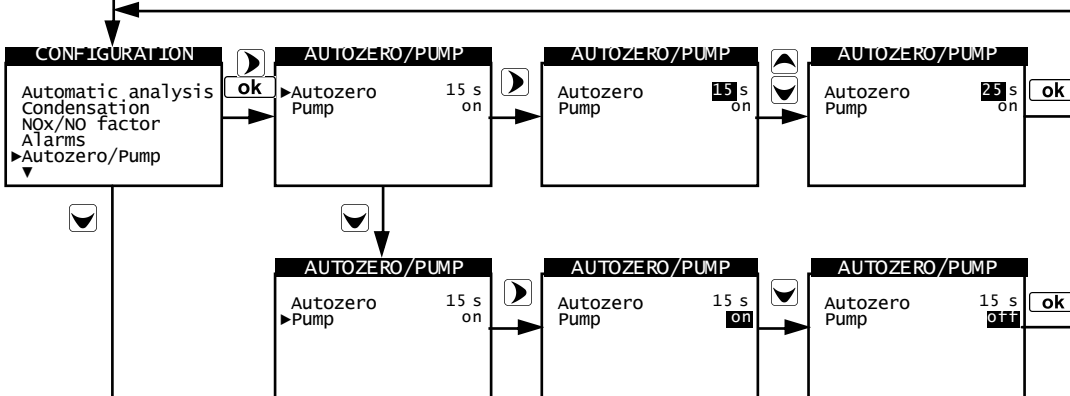

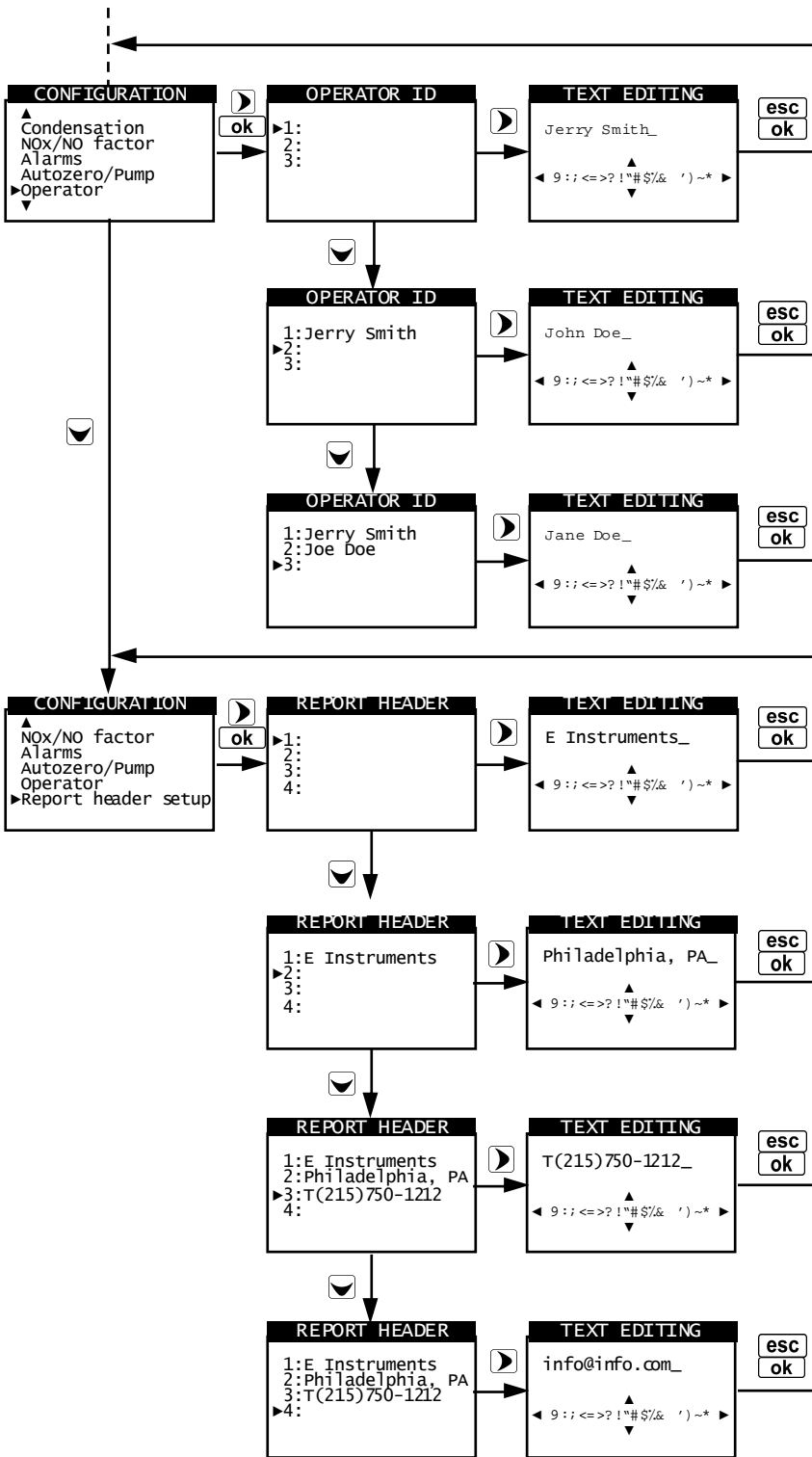

Use the "EDIT TEXT" function as follows:
Using the cursor keys, go to the box that corresponds to the letter or number required to form the desired word, and press 'ok' to confirm.

When you have finished striking in the desired text, still using the cursor keys, go to 'ok' to confirm the entered data or to 'es' to exit without saving, and press the relative 'ok' or 'esc' button. The task is done.

If you wish to modify a letter or a whole line, all you need to do is position the cursor in front of the letter to be cancelled by means of the cursor keys in the first row of controls.

At this point go to the second row of controls and press the 'esc' key on the keypad. In this way the letter preceding the cursor can be cancelled, after which the desired text can be entered or the user can confirm and exit.

4.10 Instrument configuration menu



This menu is used to configure the instrument's reference parameters described below:

Bluetooth (optional):

Through this sub menu the user can turn on and off the instrument Bluetooth wireless communication with a PC or PDA.







WHEN THE INSTRUMENT BLUETOOTH INTERFACE IS TURNED ON, THE BATTERY LIFE IS REDUCED DOWN TO 10 HOURS.

Calibration

It is possible to make a recalibration of the instrument's gas sensors with suitable known concentration gas cylinders. Recalibration of Oxygen (O₂) sensor is not available since it is already recalibrated during every autozero sequence. See 'MAINTENANCE' section.

Display contrast:

The display contrast may be increased or decreased by acting on cursor keys    . This operation may be performed even when the introductory screen is active.

Time/Date:

This allows the current time and date to be set. The user can select the date and hour format either in EU (European) or USA (American) modes.

Micromanometer

Allows to configure the micromanometer input (optional) as P+ or P- port. In case P- is selected, the sign of pressure is inverted.

Buzzer

This sub-menu allows the operator to activate or deactivate the instrument buzzer.

Language

This sub-menu permits to select the desired language for the visualization of the various menus and the report printing.

1

4.10.1 Flow Chart - Instrument configuration menu



Activates the Configuration/Information Menu.

All selected data can be modified by pressing cursor keys \blacktriangledown \blacktriangle .

To cancel changes and return to the previous menu press **esc** .

2

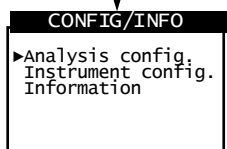

3

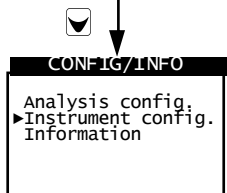

4

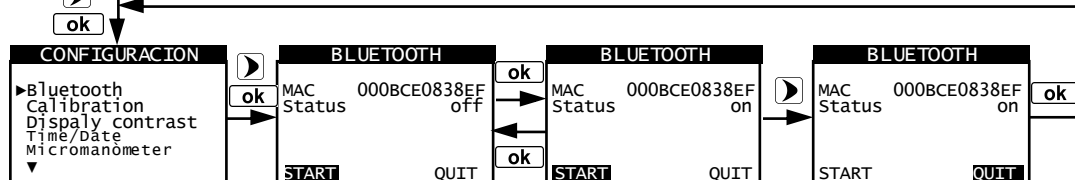

5

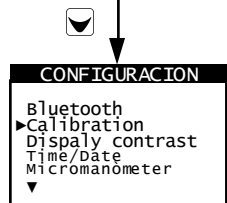

See 'MAINTENANCE' section.

6

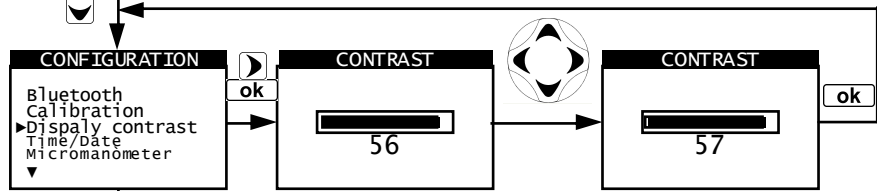

7

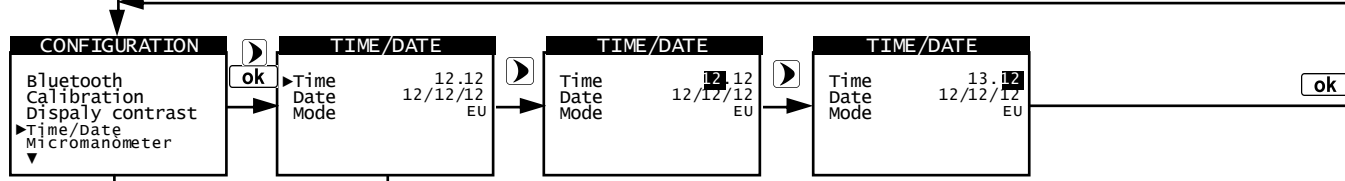

8

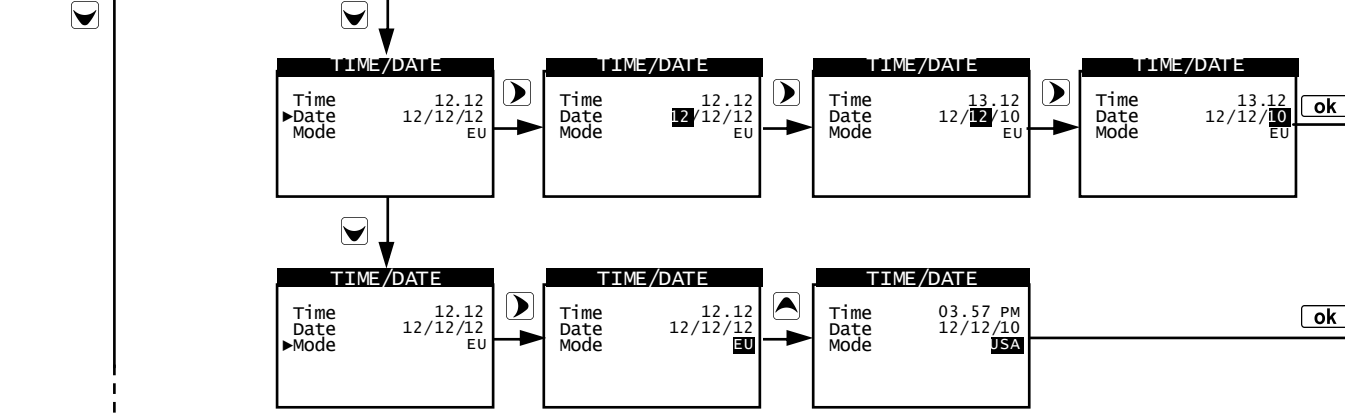



1

2

3

4

5

6

7

8

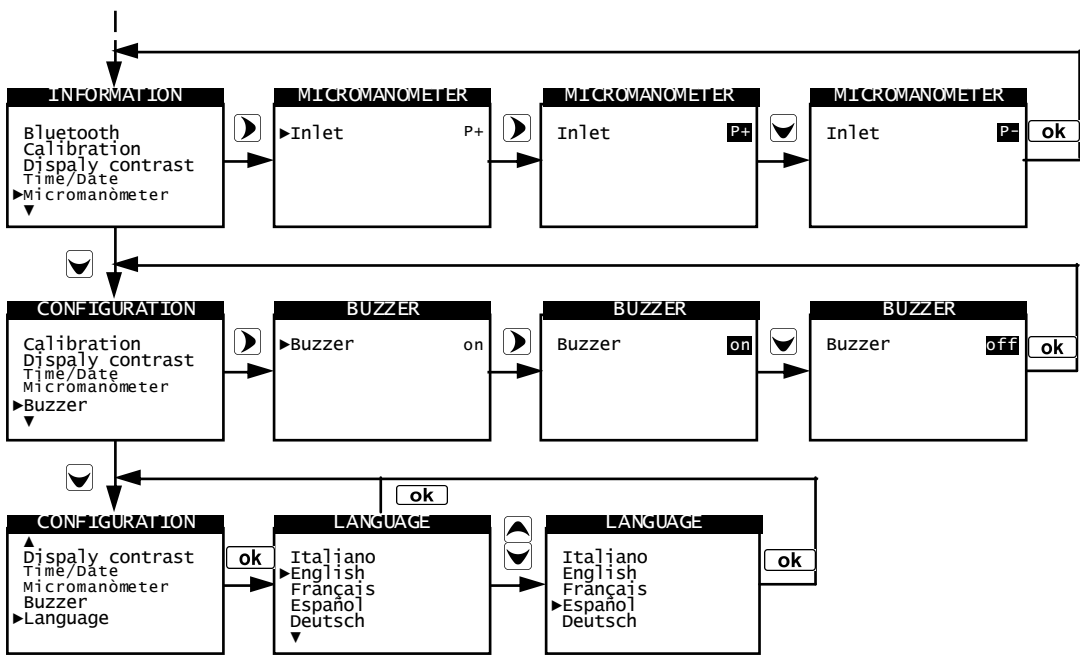

4.11 Memory Menu



This menu is used to display individual and average values of the analysis data stored in the internal memory. Analysis data can be ordered either by memory position or by storage date; draft and smoke values can also be recalled.

Save analysis:

This submenu displays the current active MEMORY and the data stored within, and allows the user to record new values or to overwrite them if these are already present and complete.

Display average:

Displays the average of the analysis data stored in the active memory.

Select memory:

Allows the user to select the memory within which to record any effected analyses or other data such as draft, smoke and ambient CO (NO) values. When the menu is accessed a preview of all saved data will appear.

Recall memory:

This menu, just like the previous one, lets the memory be selected on the basis of the stored position or storage date, thereby letting all stored data be displayed (individual and average readings, draft, smoke and ambient CO (NO) values).

Delete single:

Allows the user to erase the data stored for a single memory. A confirmation is required in order to avoid an accidental loss of the formerly stored data.

Delete all:

This is used to cancel the entire contents of the 300 memory positions; even for this option a confirmation is required in order to avoid an accidental loss of the formerly stored data.



4.11.1 Flow Chart - Memory Menu



Activates the Memory Menu. This menu is used to display and print the individual and average values of the analysis data stored in memory. Analysis data can be ordered either by memory position or by storage date; draft, smoke and ambient CO (NO) values can also be recalled. Inside the "Recall Memory" menu, the Print Menu is only enabled in the analysis screen or in the draft, smoke and ambient CO (NO) values screen.

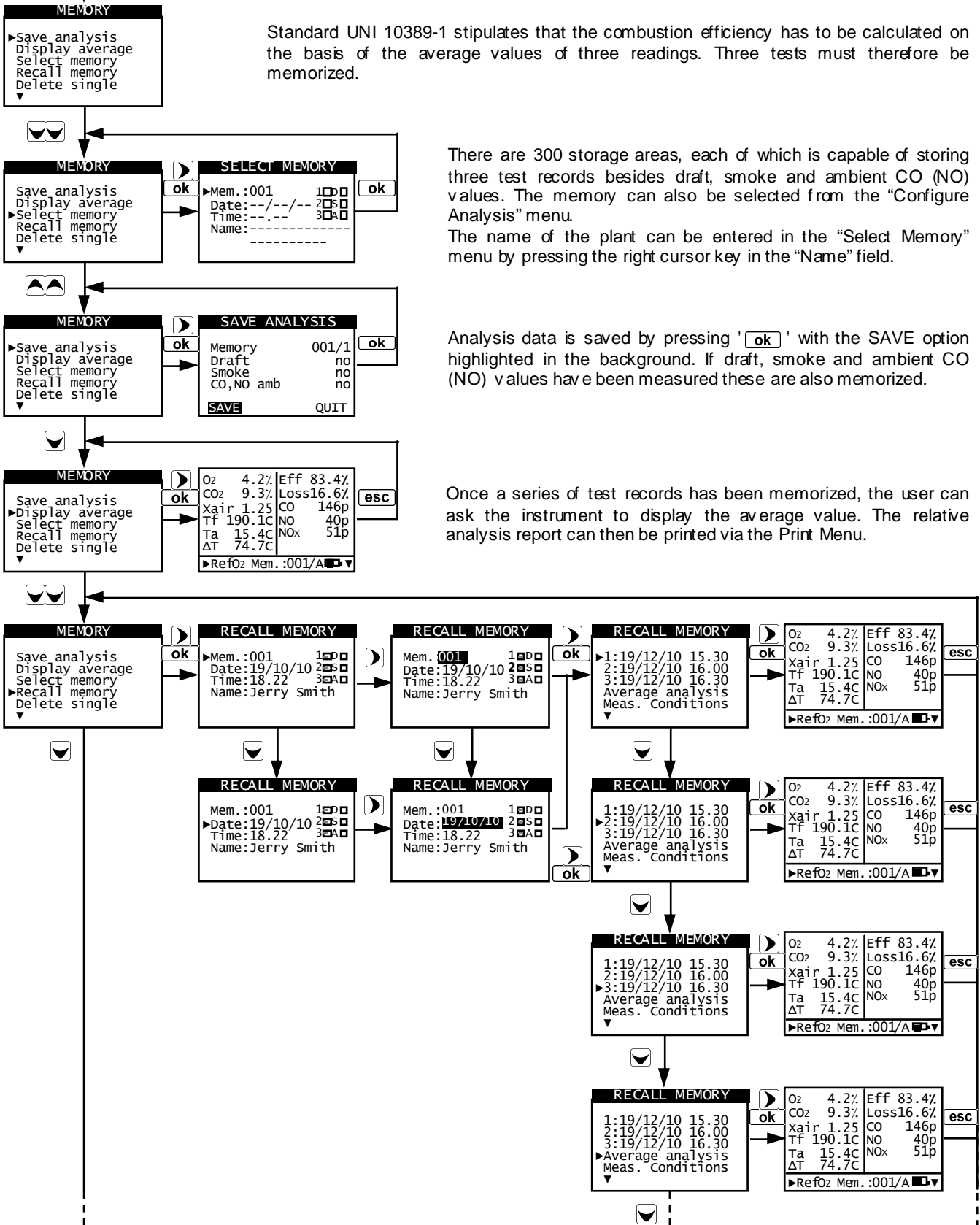

1
2
3
4
5
6
7
8



1
2
3
4
5
6
7
8

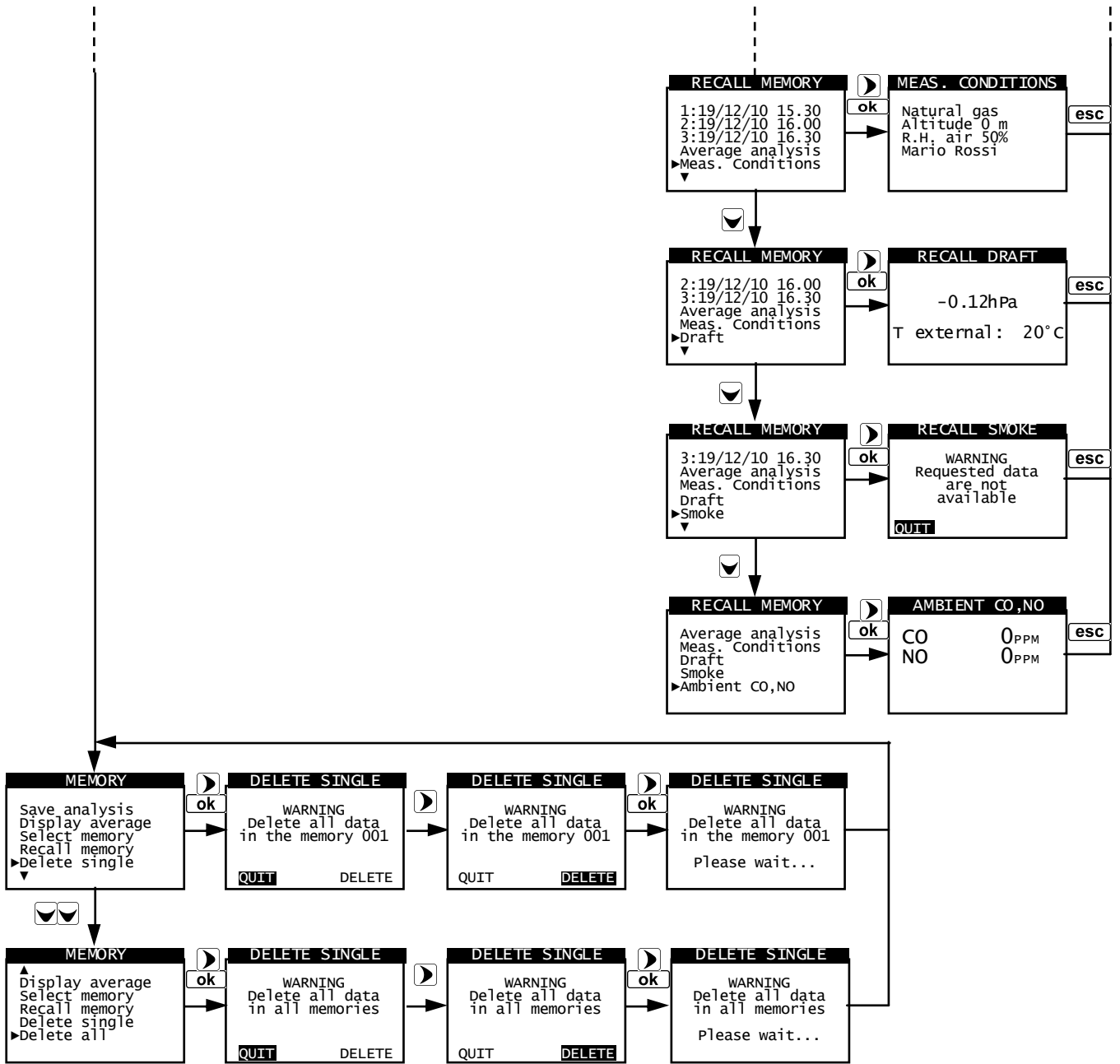



4.12 Print Menu

This menu is used to access the following print and check configurations:

Print report:

Shows the details of the selected ticket type and allows to start printing.

Print set:

Copies: Allows to set the number of printed copies and layout of the ticket

Model: The ticket layout selection is only valid for combustion analysis and can be chosen among Complete, Partial and Total. Tickets for draft, smoke and ambient gas concentration only allow a specific layout. Layouts for combustion analysis are specified as described in the following:

Full: includes a header with company data as well operator data previously programmed in the configuration menu, measurements sampled in the combustion analysis and, when sampled, the draft, smoke and CO - NO ambient gas values.

Partial: only reports the combustion analysis measurement values and information, without any header, comments or blank lines for operator comments.

Total: is arranged with the complete layout of the average analysis followed by the single analysis measurements report.

Print test:

Prints a graphical/alphanumeric test ticket for a complete check of the printer operation.

Printer type:

Selects the printer type: infrared or Bluetooth.

When infrared printer is selected a further choice for the printing mode is allowed: fast or slow (Select 'slow' in order to make the printing process compatible when an HP IR printer is used).

When Bluetooth printer is selected a pairing procedure will be needed in order to match the printer to the instrument. The pairing procedure has to be performed only once.



4.12.1 Flow Chart - Print Menu



Enables the Print Menu. Allows to print the combustion analysis data on a paper ticket which reports the measurement values. The printed values are those shown on the display when the menu is enabled. This menu can be used for combustion analysis, even when recalled from the memory, for draft, smoke and ambient gas results.

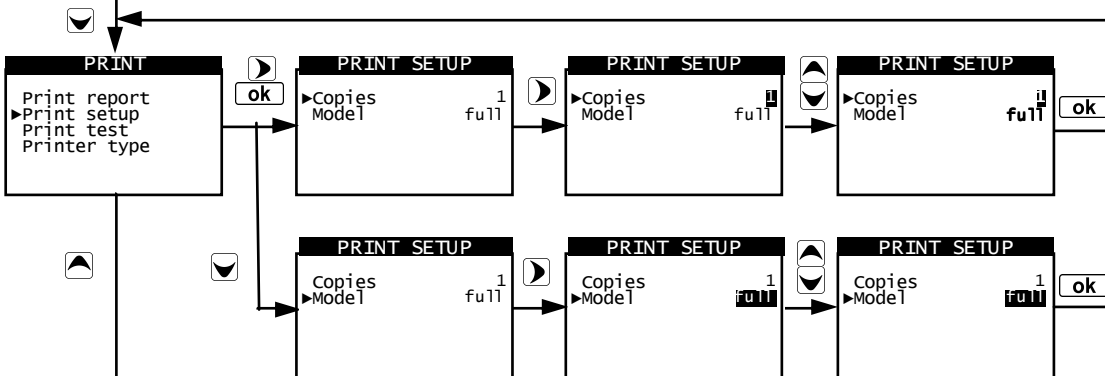

Several copies of the test ticket can be printed, choosing among different layouts according to the informations included.

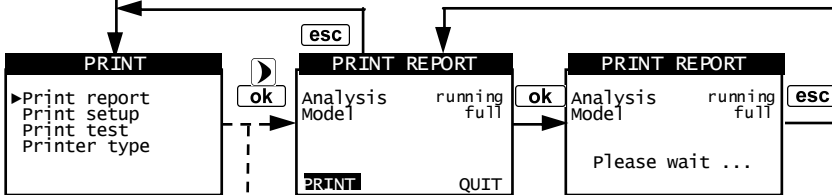

According to the values shown on the display when the menu is activated and the selected ticket layout, the user can choose among different models.

In the examples are reported the cases of printing the analysis under acquisition, printing a single analysis after recall from memory and printing an average analysis after recall from memory.

Go-ahead for printing is given by pressing 'ok' with the PRINT option highlighted in the background.

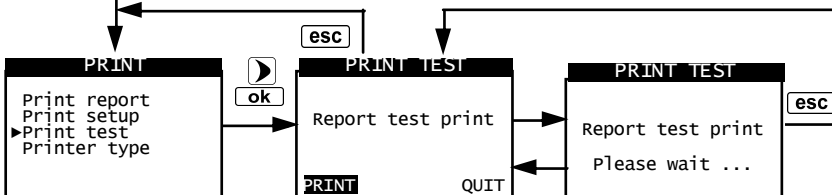
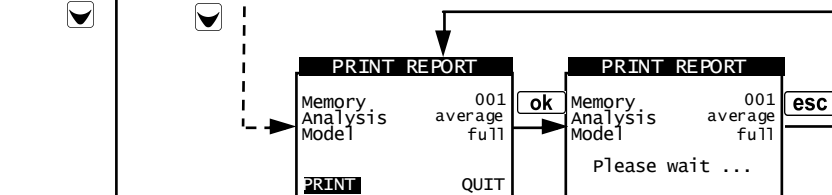
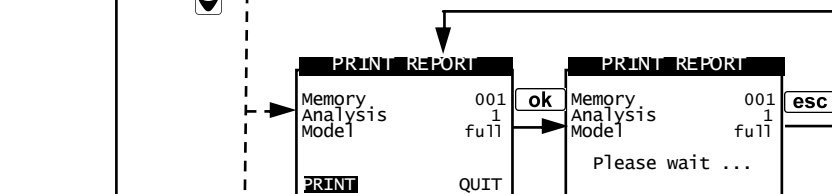

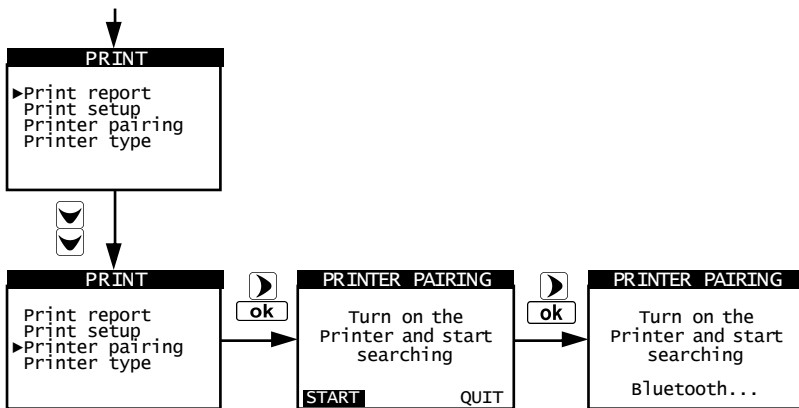
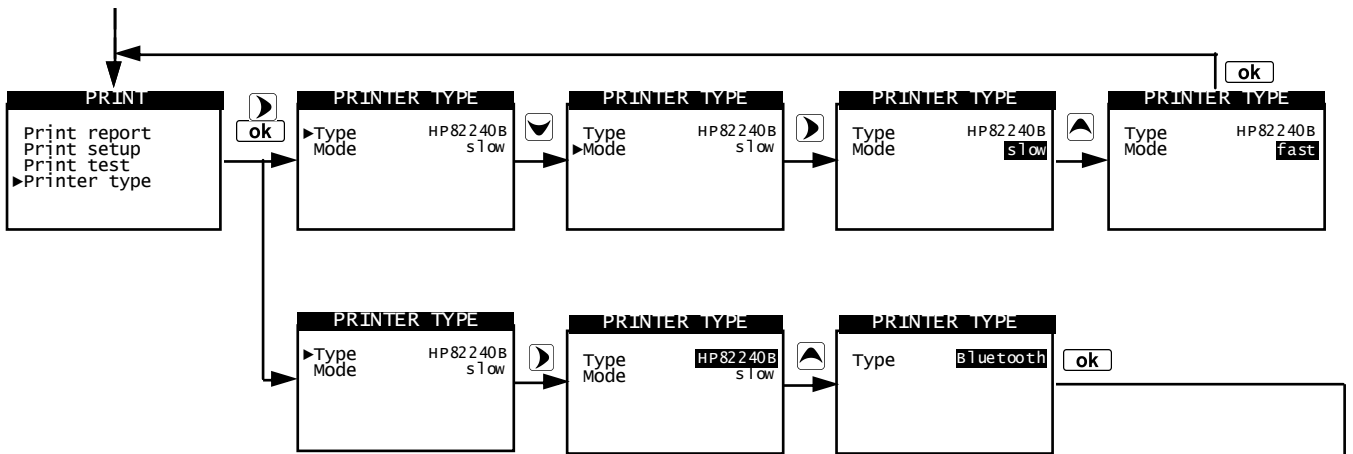

The instrument detects and shows all the Bluetooth devices found.

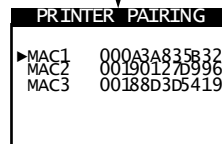

Select the MAC code of the printer that must be connected.

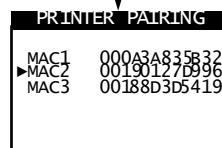

Enter the PIN code of the selected printer to complete the pairing procedure.

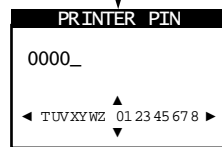

Use 'EDIT TEXT' as follows:
 With arrow the proposed code is erased.
 With arrows move the cursor to the position corresponding to the desired letter or digit in order to compose the required PIN number.
 With arrow the selected letter or digit is inserted.

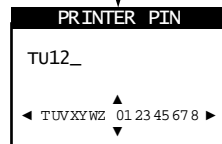

Press the key to confirm the PIN code just entered.

4.13 Analysis Menu



Through this key the analysis results are displayed. Moreover the operator is allowed, once this key is further depressed, to display and possibly modify the analysis parameters before proceeding with the measurements.

Measured values are:

O₂:	Oxygen percentage in the Flue.
CO:	CO concentration in the Flue, with low sensitivity to H ₂ (8,000 ppm full range, 1 ppm resolution).
NO:	NO concentration in the Flue (5,000 ppm full range, 1 ppm resolution).
T_f :	Flue Gas Temperature.
T_a :	Ambient / Room / Combustion Incoming Air temperature.

Calculated values are:

X_{air} :	Excess of air, ratio between the combustion air volume and the volume demanded by combustion under stoichiometric conditions.
CO₂:	Carbon dioxide percentage in the Flue gas.
ΔT :	Difference between flue gases temperature and combustion supply air temperature.
NO_x:	Nitrogen oxides concentration in flue gases.
Loss:	The sensible efficiency value is to be compared against the minimum efficiency stated for the heating systems performances.
Eff:	Total efficiency. It is the sum of sensible efficiency and the additional efficiency deriving from the recovery of water vapour condensation contained in the flue gasses, calculated according to the UNI 10389-1 standard. When it is greater than sensible efficiency, then condensation is taking place. It is referred to LHV (Lower Heating Value) and can exceed 100%.

4.13.1 Zoom function

This function can only be accessed when the analysis screen is displayed. This key is used to view the test data on a complete list or multi-page list or to zoom in on displayed text for better reading.



4.13.2 Flow Chart - Analysis Menu (zoom)

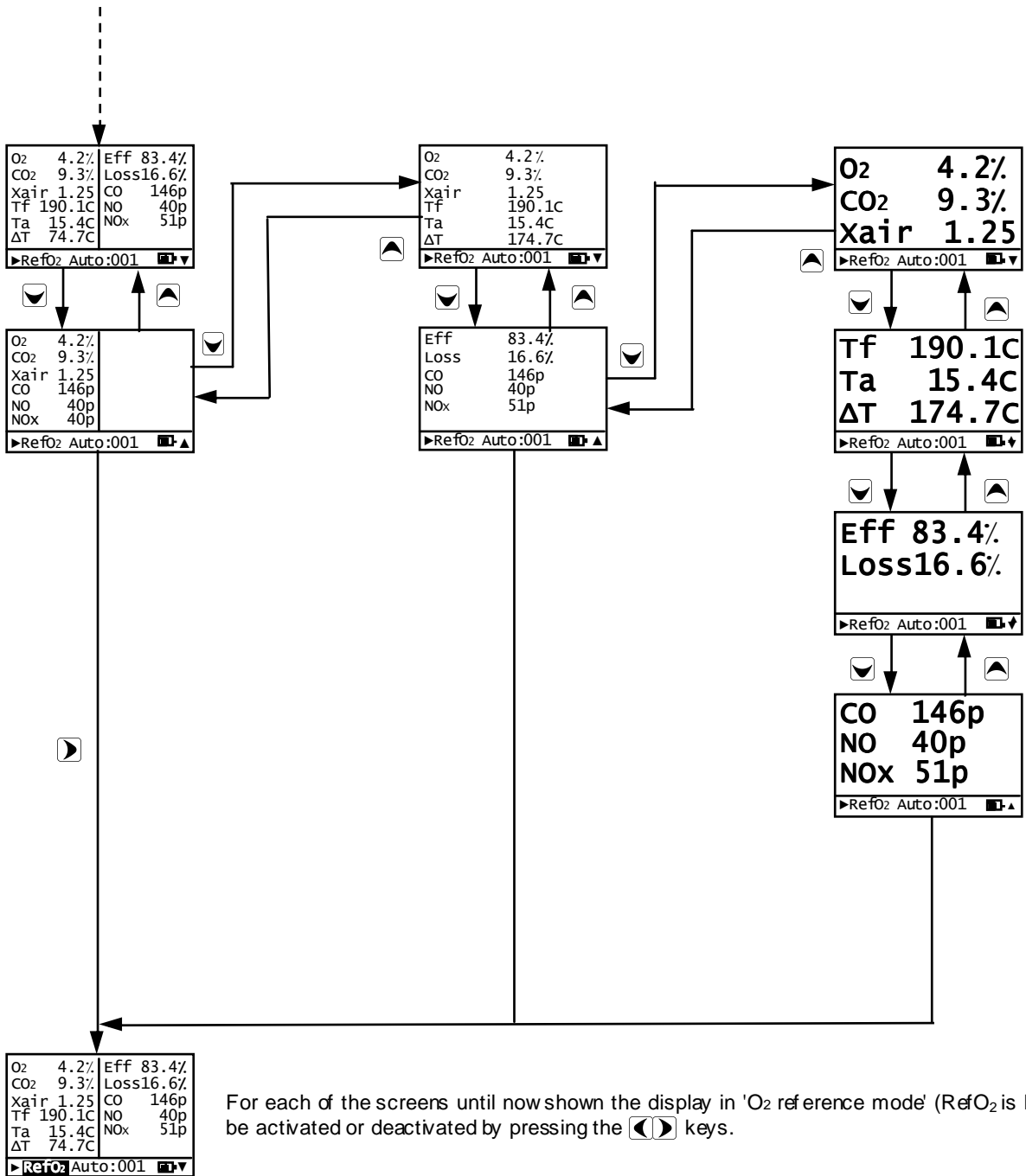

1
2
3
4
5
6
7
8



By pressing the Analysis key once more, and starting from any of the above screens, the user may proceed as follows:

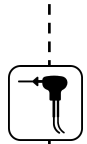

Activates the Analysis Menu.

ANALYSIS SETUP

►Mem.: 01
 Fuel.: Natural gas
 Oper.: John Smith
 Rep.: Full
 Mode: manual

SELECT MEMORY

►Mem.: 001 1□□
 Date: --/--/-- 2□□
 Time: --:--:-- 3□A□
 Name: -----

Select the memory wherein to store the acquired data.

FUEL

►Natural gas
 #2 Oil
 #4 Oil
 Diesel
 Wood/Pellets 8%

Select the fuel of the plant being tested.

OPERATOR ID

►1: Mario Rossi
 2: Luigi Bindi
 3:

Select the test operator.

PRINT SETUP

►Copies 1
 Model full
 Printer fast

Setup the report printing, selecting the number of copies, the type of report to print and the printer speed.

AUTOMATIC ANALYSIS

►Mode auto
 Duration 120 s
 Print manual

Select the analysis mode - automatic or manual. If automatic mode is selected, define the test time and print mode - automatic or manual.

4.14 Draft Menu



The DRAFT menu gives access to the stack draft measurement.

The user to input the external air temperature as required by the standard. Afterwards the measurement screen is reached: here the user can acquire the value displayed in order to add it to the running analysis measurements or, alternatively, print the relevant ticket through the 'PRINT' menu.

NOTE: The measurement may not be accurate due to condensation inside the sample probe. Should you notice an inaccurate or unstable reading on the instrument, it is advisable to disconnect the sample probe from the instrument itself, and purge pipes by blowing with a compressor. In order to be sure there is no humidity, it is suggested to perform the measurement by means of the transparent rubber pipe supplied on issue.

4.14.1 Flow Chart - Draft Menu

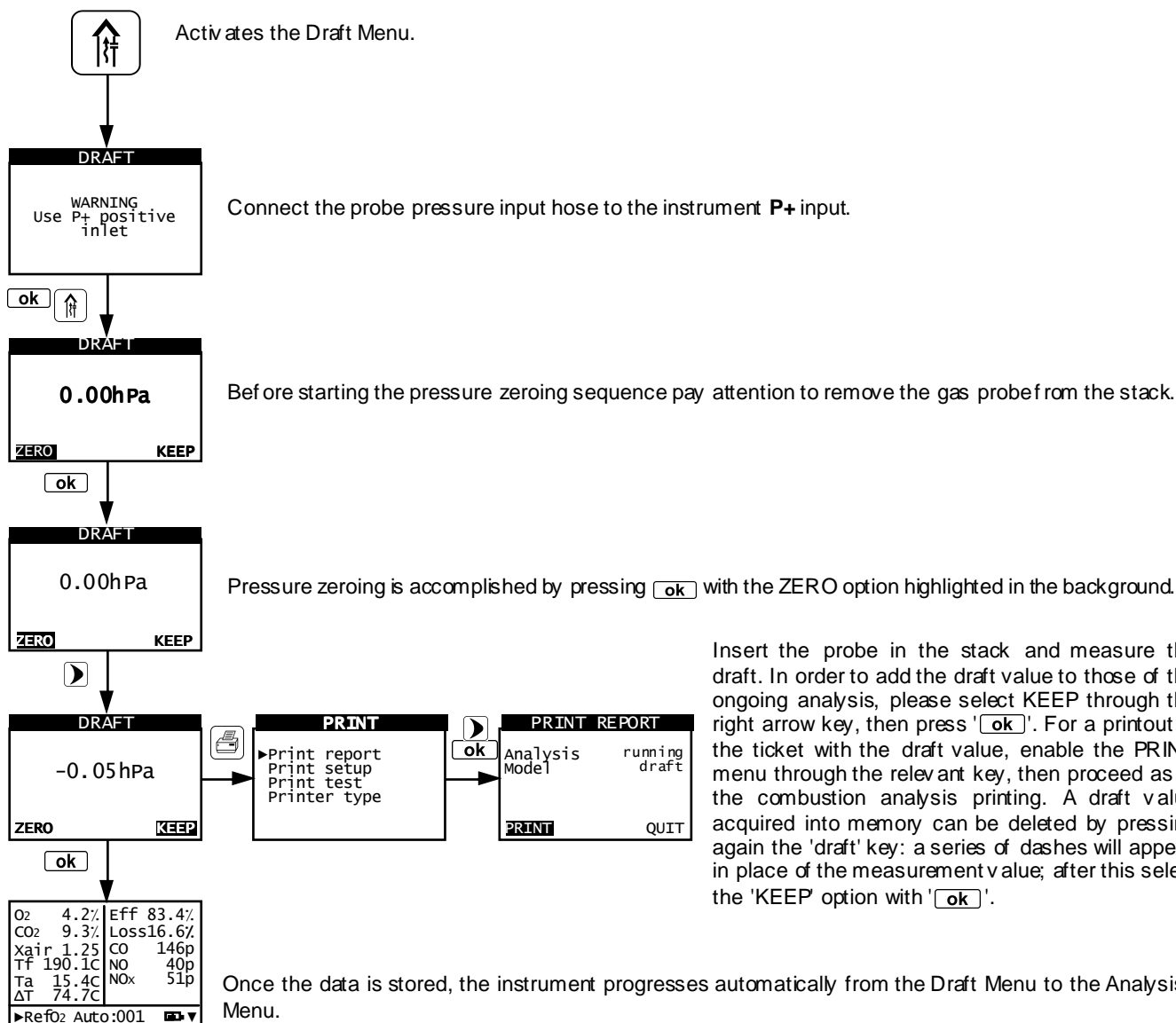

NOTE: The draft values to be stored in the memory must be acquired before storing the analysis data.

1
2
3
4
5
6
7
8

4.15 Measurements Menu



This menu is used to access the following readings:

Smoke:

It is possible to enter the data for up to three (3) separate Smoke test measurements taken by means of an optional device (SMOKE PUMP); see the relevant instructions.

The method consists in taking a certain quantity of combustion gas from the middle of the flue behind the surfaces of the exchangers at the end of the boiler, and make it pass through a special filter paper. The soot stain obtained is compared with the surfaces blackened in a different way according to a comparison scale; it is thus determined the "soot number", which will be entered in the instrument by hand.

These measurements can be either stored in memory together with the combustion analysis data or printed on a report ticket.

Ambient CO, NO:

This function allows the operator to easily visualize the peak values of CO and NO in the ambient in order to verify that acceptable safety conditions are present in the ambient before people enter in it. It is recommended to respect the concentration limits stated in the following safety standards:

COmax: 35 ppm Recommended exposure limit (REL) stipulated by the National Institute for Occupational Safety and Health (NIOSH), equivalent to 40 mg/m^3 and calculated as an 8-hour Time-Weighted Average (TWA).

NOmax: 25 ppm Recommended exposure limit (REL) stipulated by the National Institute for Occupational Safety and Health (NIOSH), equivalent to 30 mg/m^3 and calculated as an 8-hour Time-Weighted Average (TWA).

ATTENTION: it is REQUIRED to perform the autozero in the clean air, so that the ambient CO and NO measurement are correct. It is advisable to turn on the instrument and wait for the autozero completion outside the area where the test is being performed (preferably OUTSIDE).

The result of the test can be either associated to the combustion analysis and consequently stored in memory or immediately printed through the 'Print' menu.

Pressure:

It is possible, through the use of the external flexible pipe made in RAUCLAIR (supplied), to measure a pressure value within the range stated in the technical features (connect the pipe to P+ input). During the pressure measurement the 'HOLD' function is made available, which allows to 'freeze' the value shown on the display, by pressing 'HOLD' key.

TcK Temperature:

The user can measure the temperatures within the range specified in the technical specifications (e.g. plant delivery temperature) by using an OPTIONAL Type K thermocouple contact probe connected to the TcK input.

Pt100 Temperature:

The ambient temperature can be measured within the range specified in the technical specifications by connecting the remote air temperature probe provided with the instrument to the Pt100 input the pressure decays in time during a fixed 15 minutes interval, as stated in the applied standard.



1

4.15.1 Flow Chart - Readings Menu



Activates the Smoke Menu.

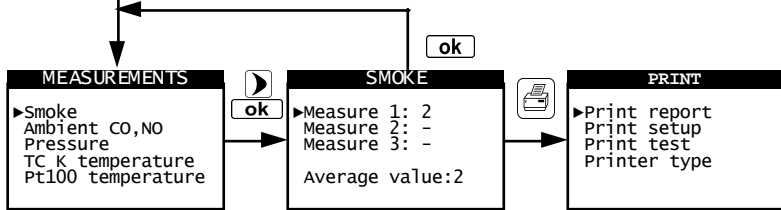

In the Smoke menu the user can input the smoke value. The values entered with the arrow keys can be associated with the ongoing analysis through the 'ok' key or printed with the Print menu.

2

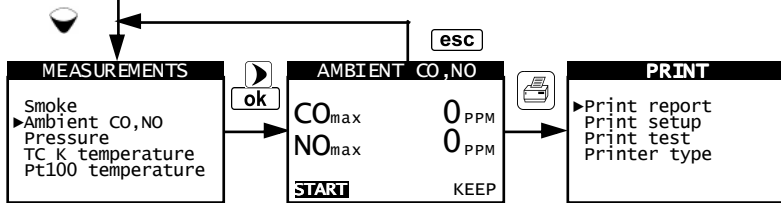

The CO, NO ambient gas gives a measurement about the safety of the environment in which the operator is working. The concentration values can be associated to the ongoing analysis with the 'ok' key, or printed through the Print menu.

3

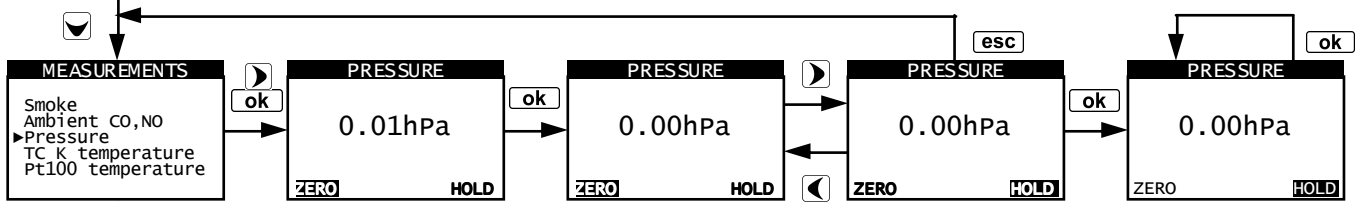

4

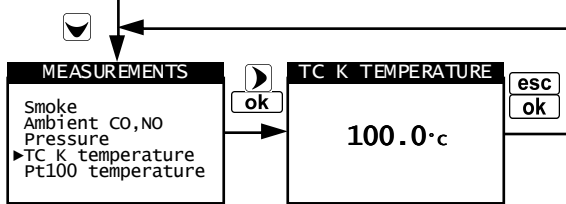

5

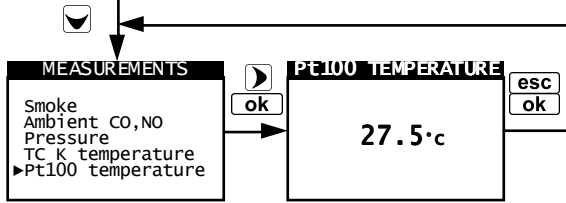

6

7

8

1
2
3
4
5
6
7
8

4.16 Flow Chart - Configure Analysis Menu

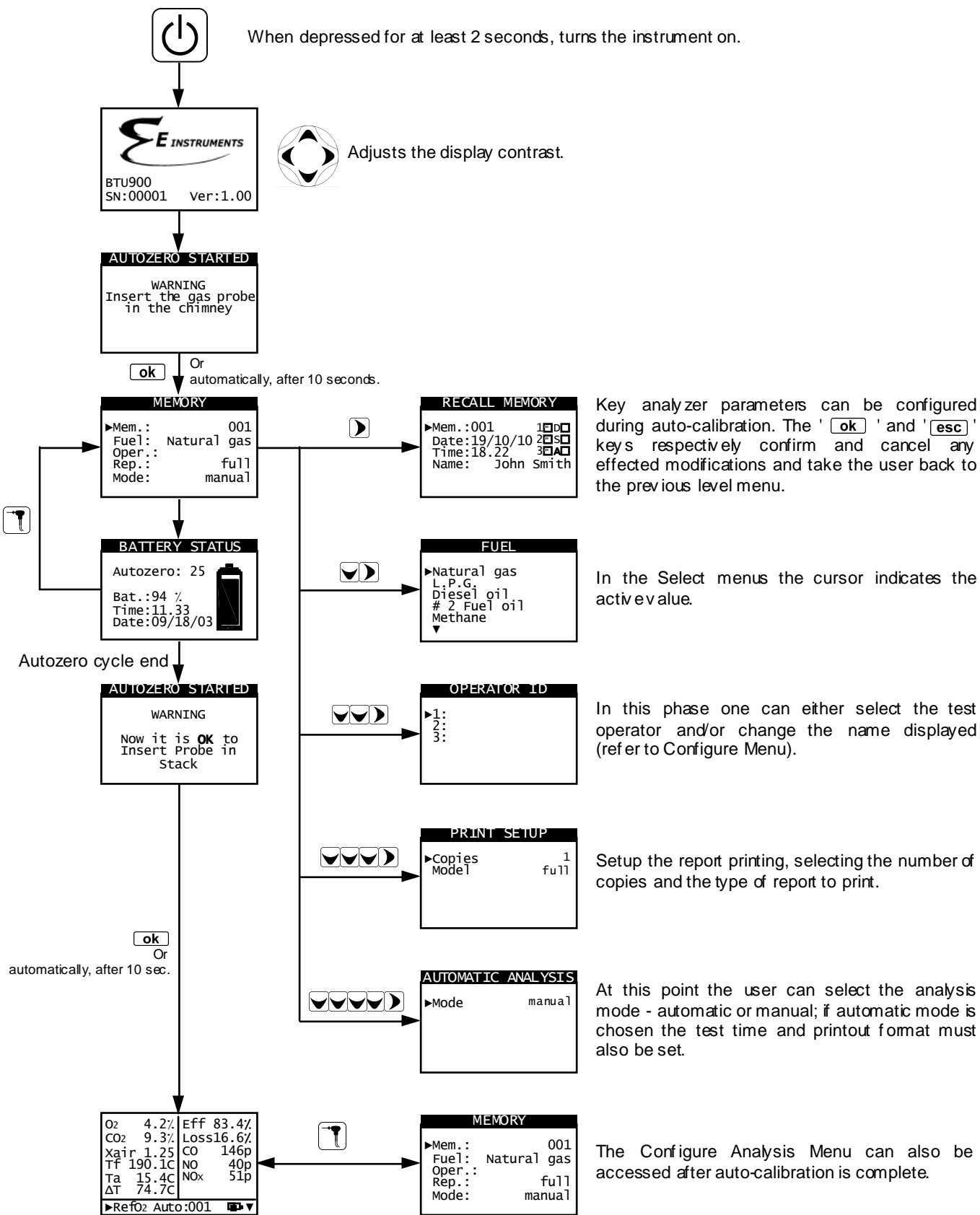

4.17 FLUE GAS ANALYSIS

To perform complete flue gas analysis, follow the instructions below.

ATTENTION

SOME IMPORTANT WARNINGS TO CONSIDER DURING THE COMBUSTION ANALYSIS ARE LISTED BELOW:

FOR A CORRECT ANALYSIS NO AIR SHOULD FLOW INTO THE PROBE FROM OUTSIDE DUE TO A BAD TIGHTENING OF THE CONE OR A LEAK IN THE PIPELINE.

THE SAMPLING PROBE & HOSES MUST BE CHECKED IN ORDER TO AVOID ANY LEAKAGES OR OBSTRUCTIONS.

THE CONNECTORS OF THE SAMPLE PROBE AND THE CONDENSATE FILTER (WATER TRAP) MUST BE WELL CONNECTED TO THE INSTRUMENT.

KEEP THE CONDENSATE TRAP IN THE VERTICAL POSITION DURING THE ANALYSIS; A WRONG POSITIONING MAY CAUSE CONDENSATE LEAKAGES IN THE INSTRUMENT AND THUS DAMAGE THE SENSORS.

DO NOT PERFORM ANY MEASUREMENT WHEN THE FILTER IS REMOVED OR DIRTY IN ORDER TO AVOID ANY RISK OF PERMANENT SENSOR DAMAGE.



4.17.1 Switching on the instrument and auto-calibration

Press the On/Off key to switch on the instrument - an introductory screen will appear. After a couple of moments the instrument will zero itself and will state that the sample probe should not be inserted in the stack.

It is important that the sample probe is not inside the stack since, during auto-calibration, the instrument draws fresh air from the environment and detects the zero value of the gas sensors, the details of which are then memorized and used for reference during the analysis. It is equally important that this phase is performed in a fresh-air environment.

The pressure sensor is also zeroed during auto-calibration.

4.17.2 Inserting the probe inside the stack

When auto-calibration is complete the instrument will instruct the user to insert the sample probe that has been previously connected to the relative input on the instrument, and the analysis screen will appear automatically.

In order for the probe to be inserted at the right point within the stack, its distance from the boiler has to be twice the diameter of the stack pipe itself or, if this is not possible, must comply with the boiler manufacturer's instructions.

In order to position the probe correctly, a reliable support must be provided by drilling a 13/16 mm hole in the manifold (unless already present) and screwing in the positioning cone provided with the probe - in this way no air is drawn from the outside during sampling.

The screw on the cone allows the probe to be stopped at the right measuring depth - this usually corresponds to the center of the exhaust pipe. For greater positioning accuracy, the user may insert the probe gradually into the pipe until the highest temperature is read. The exhaust pipe must be inspected before carrying out the test, so as to ensure that no constrictions or losses are present in the piping or stack.



4.17.3 Flue Gas Analysis

After the sample probe has been inserted in the stack and the combustion air temperature probe (if used) has been inserted in the relative sample manifold, if the instrument has not been configured during auto-calibration, the following data must be configured:

Memory: use this submenu to define the memory in which the test data and client details are to be stored.

1

Fuel: the user will be asked to define the type of fuel used by the plant.

Operator: this is where the name of the test operator can be entered.

Mode: by entering this submenu, the user can determine the analysis mode - manual or automatic.

If automatic mode is chosen, the reading duration of each and every test must be set, besides the printing mode - manual or automatic. When flue gas analysis begins, the instrument will perform and memorize the three tests automatically, at the respective intervals set (at least 120 sec. according to UNI 10389-1).

At the end of each test the instrument will emit an audible alarm (one "beep" after the first test, two "beeps" after the second test and three "beeps" after the third test).

At this point, when all three tests are over, if "Manual Printing" has been chosen the instrument will display the average of the three tests with the possibility of recalling the individual values.

If desired, the user can then print the relative data (total, complete, etc....). On the contrary, if "Automatic Printing" was selected, the instrument will print the test data automatically, based on the current print settings, without displaying the average test values.

Caution: when in automatic mode Draft, Smoke and ambient CO (NO) measurements must be taken before initiating the flue gas analysis.

If, on the other hand, manual analysis mode is chosen, flue gas analysis will proceed manually (please see relative Flow Chart). In this case the print settings and automatic test duration will not be considered.

At this point manual analysis may commence, first waiting at least two minutes until the displayed values stabilize: The user can then proceed with data storage, if required, or print the analysis report directly.

The latter will be printed in the format set beforehand.

When all three tests are over, the user can recall the average analysis screen containing all the data necessary for compiling the maintenance log of the boiler or plant.

In both automatic and manual modes, all the pollutant values (such as CO / NO / NO_x) can be translated into normalized values (referenced to the previously defined O₂ level) by simply pressing the button .

4.17.4 End of Analysis

At the end of the combustion analysis, carefully remove the sample probe and remote air temperature probe, if used, from their relative ducts, taking care not to get burnt. Then carefully disconnect the water trap, hoses, and sampling probe from the analyzer.

Switch off the instrument by pressing the On/Off key.

At this point, if the instrument has detected a high concentration of CO and/or NO, a self-cleaning cycle will be initiated during which the pump will draw fresh outside air until the gas levels drop below acceptable values.

At the end of the cycle (lasting no longer than 3 min.) the instrument will switch itself off automatically.

2

3

4

5

6

7

8

4.17.5 Flow Chart - Flue Gas Analysis

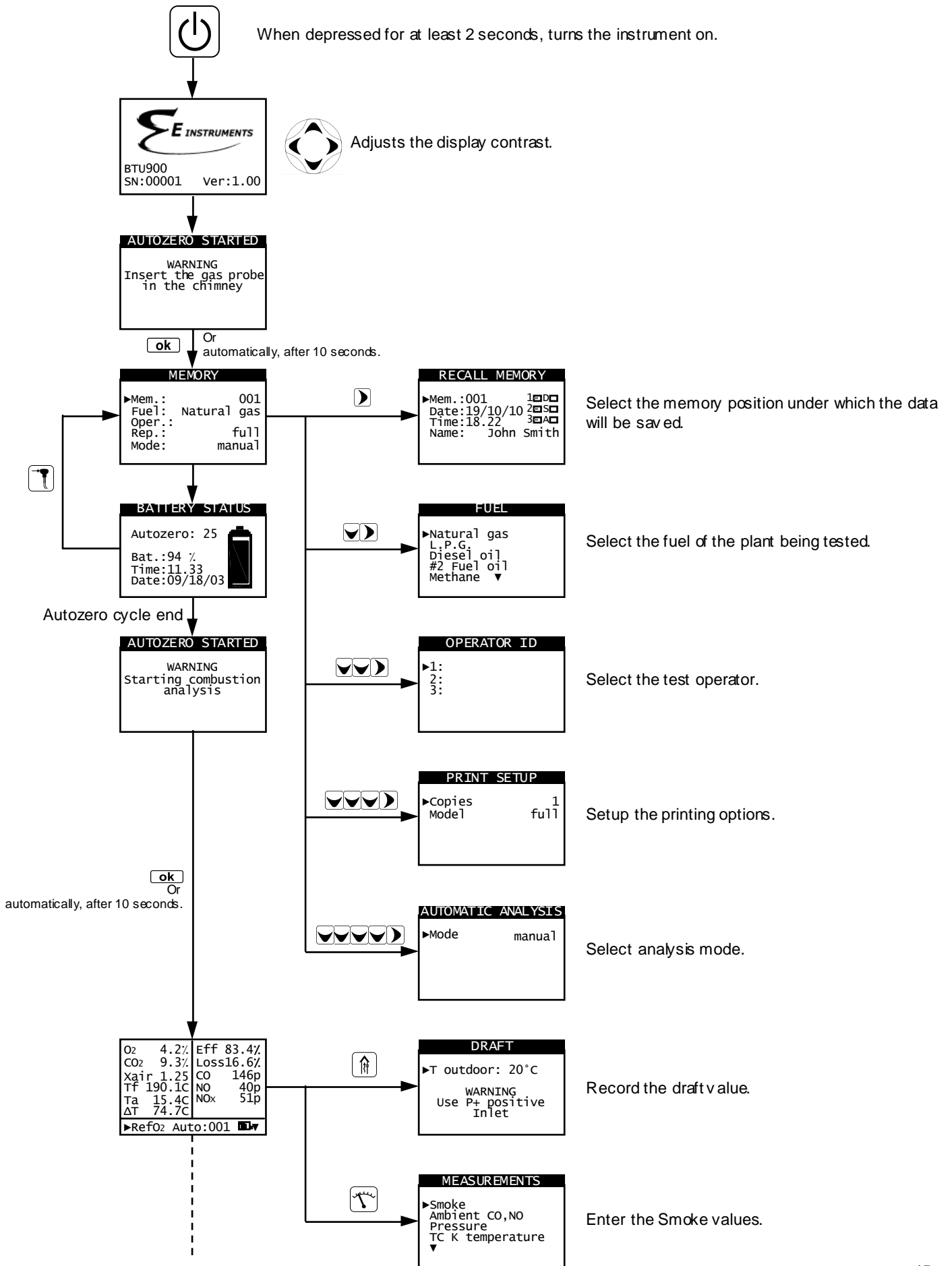

1
2
3
4
5
6
7
8

1
2
3
4
5
6
7
8

How to proceed in manual mode (standard sequence).

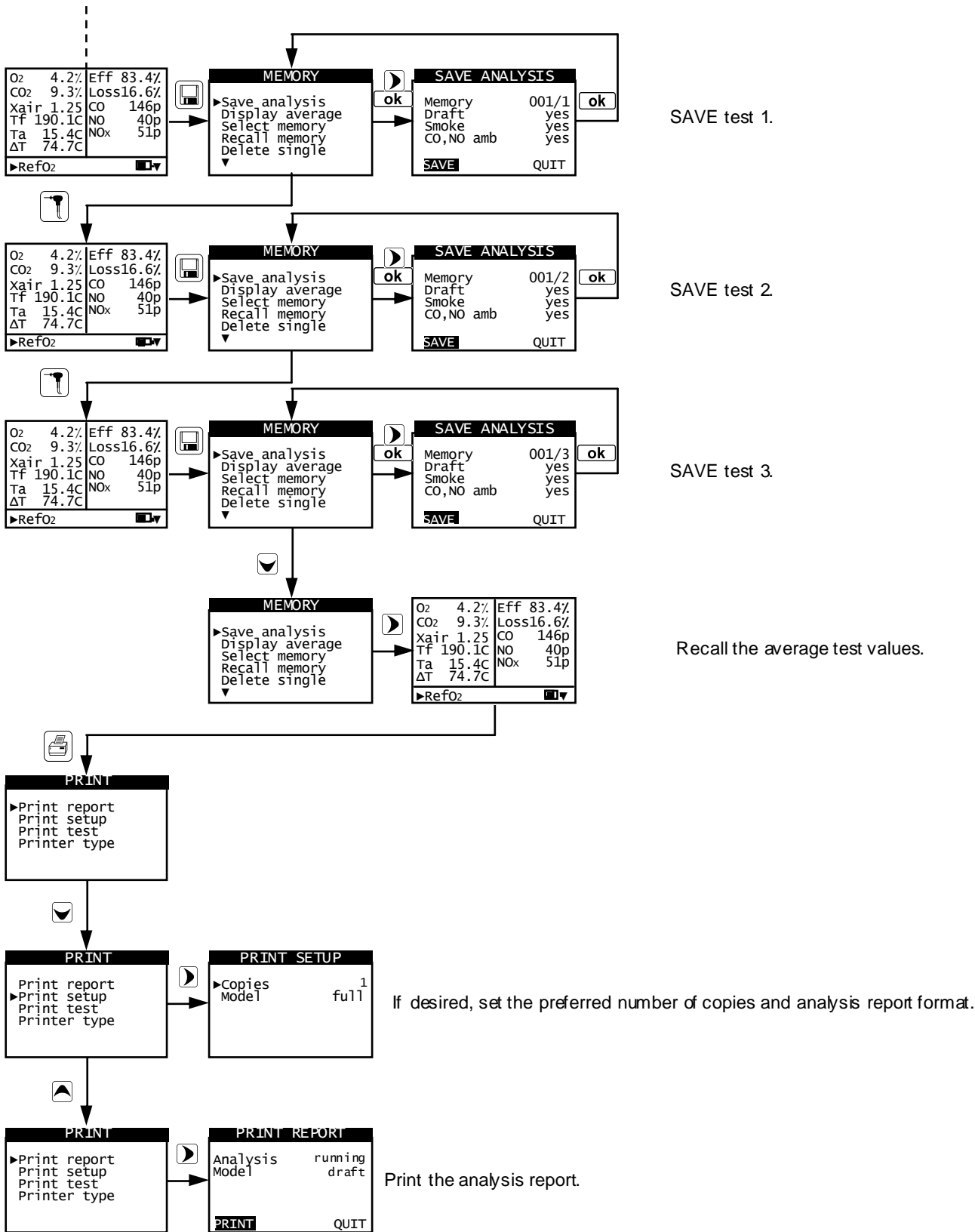

When printing is complete return to the Analysis Menu by pressing:



O2	4.2%	Eff	83.4%
CO2	9.3%	Loss	16.6%
Xair	1.25	CO	146p
Tf	190.1C	NO	40p
Ta	15.4C	NOx	51p
ΔT	74.7C		
▶RefO2			

The system is ready to carry out further tests.

How to proceed in manual mode (quick sequence).

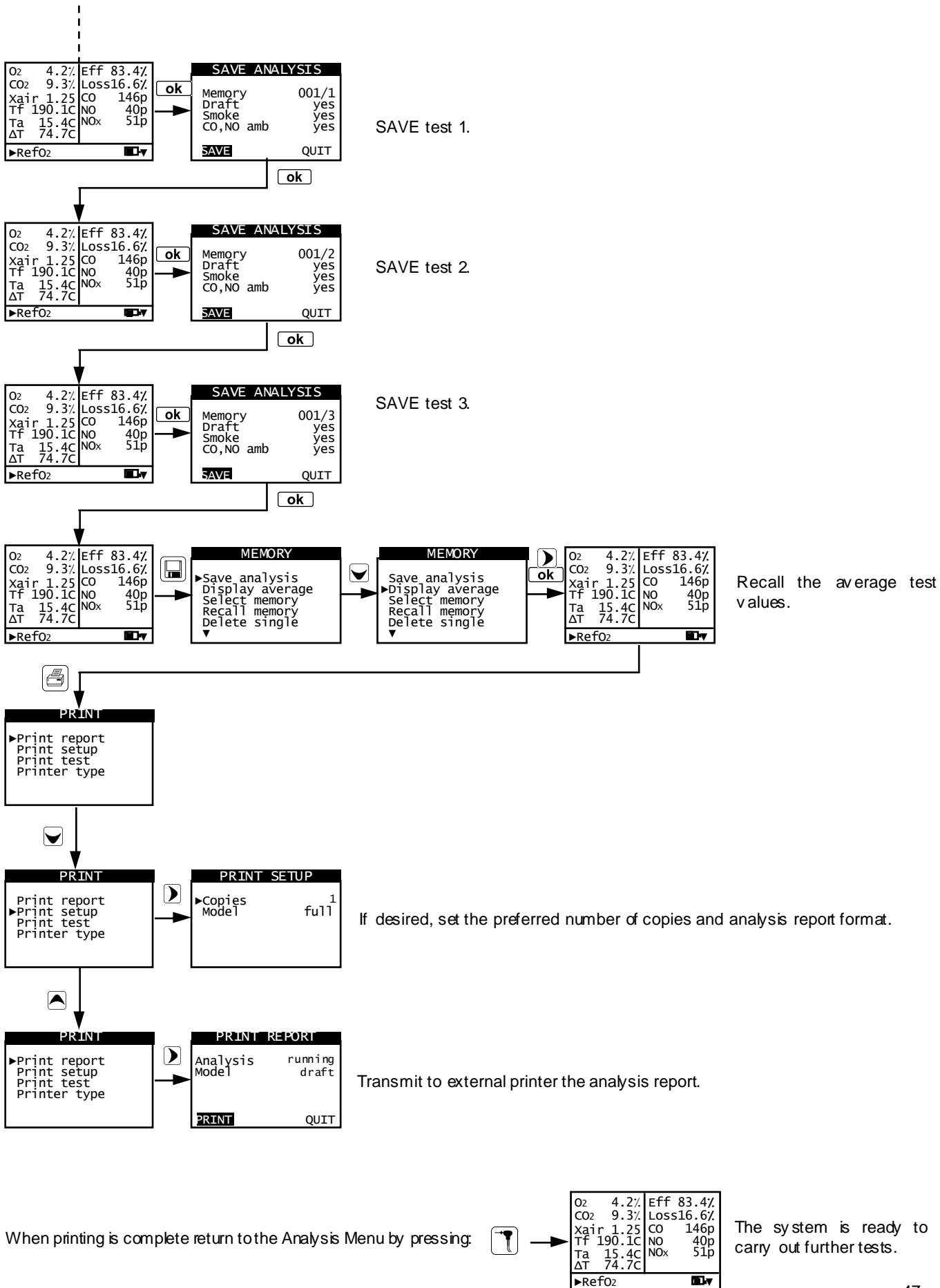

1
2
3
4
5
6
7
8

How to proceed in automatic mode.

O2	4.2%	Eff	83.4%
CO2	9.3%	Loss	16.6%
Xair	1.25	CO	146p
Tf	190.1C	NO	40p
Ta	15.4C	NOx	51p
ΔT	74.7C		
▶RefO2			

ok

O2	4.2%	Eff	83.4%
CO2	9.3%	Loss	16.6%
Xair	1.25	CO	146p
Tf	190.1C	NO	40p
Ta	15.4C	NOx	51p
ΔT	74.7C		
▶RefO2 001/1:120			

Automatic, when the defined time elapses.

O2	4.2%	Eff	83.4%
CO2	9.3%	Loss	16.6%
Xair	1.25	CO	146p
Tf	190.1C	NO	40p
Ta	15.4C	NOx	51p
ΔT	74.7C		
▶RefO2 001/2:120			

Automatic, when the defined time elapses.

O2	4.2%	Eff	83.4%
CO2	9.3%	Loss	16.6%
Xair	1.25	CO	146p
Tf	190.1C	NO	40p
Ta	15.4C	NOx	51p
ΔT	74.7C		
▶RefO2 001/3:120			

Automatic, when the defined time elapses.

O2	4.2%	Eff	83.4%
CO2	9.3%	Loss	16.6%
Xair	1.25	CO	146p
Tf	190.1C	NO	40p
Ta	15.4C	NOx	51p
ΔT	74.7C		
▶RefO2 001/A:120			

If, when configuring test parameters, manual printing has been selected (see example), the average values will be displayed after the third test values have been read. These may be sent to printer by activating the relative menu. If, on the other hand, automatic printing has been selected, the average test values will be printed automatically.

Automatically, after a few seconds, the report is printed.

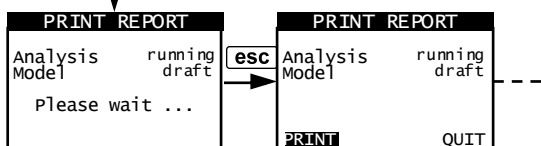

When printing is complete return to the Analysis Menu by pressing:



O2	4.2%	Eff	83.4%
CO2	9.3%	Loss	16.6%
Xair	1.25	CO	146p
Tf	190.1C	NO	40p
Ta	15.4C	NOx	51p
ΔT	74.7C		
▶RefO2			

The system is ready to carry out further tests.

4.18 Measuring the Differential Pressure (OPTIONAL HOSE KIT) (Part # AACKP01)

The instrument is fitted with an internal temperature-compensated piezoresistive transducer to measure positive and negative pressures. This sensor, which is mounted on the instrument, is of the differential type.

If the special KIT is purchased, the sensor can be used to measure the differential pressure thanks to the positive and negative pressure connectors.

The measuring range varies between -4.014 inH₂O and +80.292 inH₂O.

5.0 SENSORS

5.1 Sensors arrangement

SENSORS ARRANGEMENT INSIDE THE SENSORS COMPARTMENT

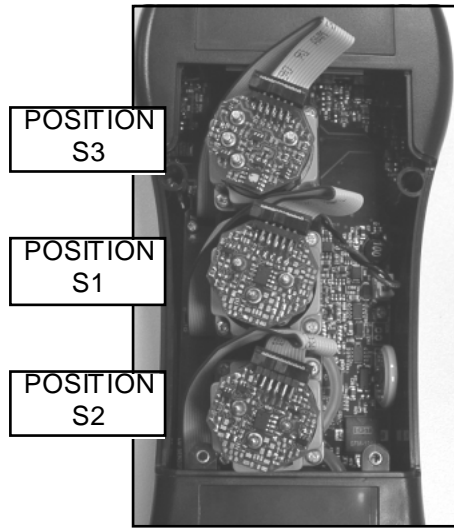

GRAPHICAL DISPLAY OF ARRANGEMENT

SENSORS TYPE	
O ₂	<input type="checkbox"/> 1 <input type="checkbox"/> 3 NO
CO	<input type="checkbox"/> 2
<input type="button" value="QUIT"/>	

5.2 Sensor types and relevant positioning

CODE \ POSITION	S1	S2	S3
FLEX-Sensor O₂ Cod. AAC SE15	✓		
FLEX-Sensor CO (Low H₂) Cod. AAC SE20		✓	
FLEX-Sensor NO Cod. AAC SE10			✓

5.3 Gas sensor life

The gas sensors used in this instrument are electrochemical: thus, when the relative gas is detected, a chemical reaction takes place inside them that generates an electrical current.

The electrical current acquired by the instrument is then converted into the corresponding gas concentration. Sensor life is strongly related to the consumption of the reagents within.

Sensor characteristics diminish as the reagents are consumed and when these have been used up completely the sensor must be replaced. The sensors must be recalibrated on a regular basis to assure measuring accuracy: recalibration can only be performed by a qualified E Instruments Service Center. Chart 5.4 illustrates the characteristics inherent to each sensor.

5.4 Gas sensors life table

CODE	MEASURED GAS	AVERAGE LIFE	RECALIBRATION
FLEX-Sensor O₂ Cod. AAC SE15	O ₂ Oxygen	>24 months	not necessary
FLEX-Sensor CO (Low H₂) Cod. AAC SE20	CO Carbon Monoxide	>36 months	Yearly ⁽¹⁾
FLEX-Sensor NO Cod. AAC SE10	NO Nitrogen Oxide	48 months	Yearly ⁽¹⁾

Notes:

(1) UNI 10389-1 standard requires for the instrument calibration once per year to be performed in a laboratory authorized to issue calibration certificates.

5.5 Expandability to 3 sensors

In the BTU900 instrument range, one expandable version is available:

BTU900 - HE : 2 sensors, expandable to 3 sensors.
BTU900 - Oil

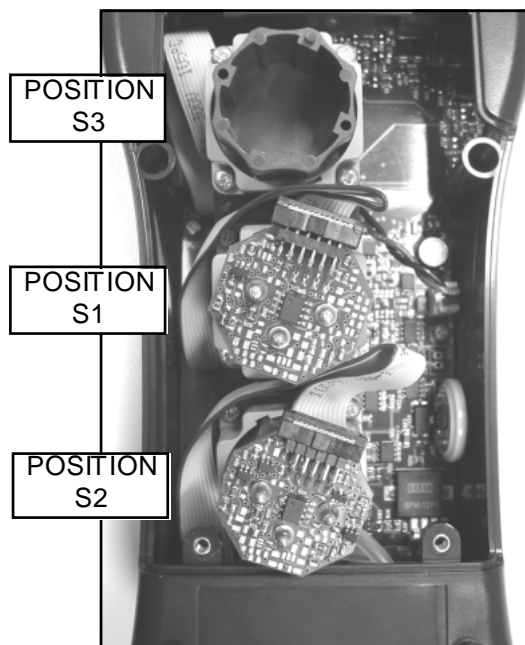

The upgrading of the number of sensors can be easily done by the user by performing the following directions:

- The expandable instrument is arranged in a way to accept one sensor in positions S3.
- Identify, with the help of paragraph 5.2 'Sensor types and relevant positioning' the sensor which must be added to the existing configuration.
- To install the new sensors follow all the steps described in the paragraph 'MAINTENANCE' under 'gas sensors replacement'.

6.0 MAINTENANCE

6.1 Routine maintenance

This instrument was designed and manufactured using top-quality components. Proper and systematic maintenance will prevent the onset of malfunctions and will increase instrument life altogether.

The following basic requisites are to be respected:

- Do not expose the instrument to substantial thermal shocks before use. If this happens, wait for the temperature to return to normal working values.
- Do not extract flue gas samples directly without using a particulate/water trap.
- Do not exceed sensor overload thresholds.
- When the analysis is over disconnect the sample probe and let BTU900 draw fresh air for a few minutes, or at least until the displayed parameters return to their original values.
- Clean the filter unit when necessary, replacing the particulate filter and applying a jet of air to the sample probe hose to remove any condensate that may have formed.

Do not clean the instrument with abrasive cleaners, thinners or other similar detergents.

6.2 Preventive maintenance

At least once a year send the instrument to a SERVICE CENTER for a complete overhaul and thorough internal cleaning.

E Instruments' highly qualified staff is always at your disposal and will provide you with all the sales, technical, application and maintenance details required.

The service center will always return the instrument to you as new and in the shortest time possible. Calibration is performed using gases and instruments comparable with National and International Specimens. Annual servicing is accompanied by a specific calibration certificate that is a guarantee of perfect instrument performance as required by UNI 10389-1, besides being indispensable for users wishing to maintain ISO 9000 status.

6.3 Cleaning the sample probe

When you finish using the sample probe clean it thoroughly as described below before returning it to its case:

- Disconnect the sample probe from the instrument and from the water trap (Fig. a-b) then blow a jet of clean air into the hose of the probe (refer to Fig. c) to remove any residual condensate that may have formed within.

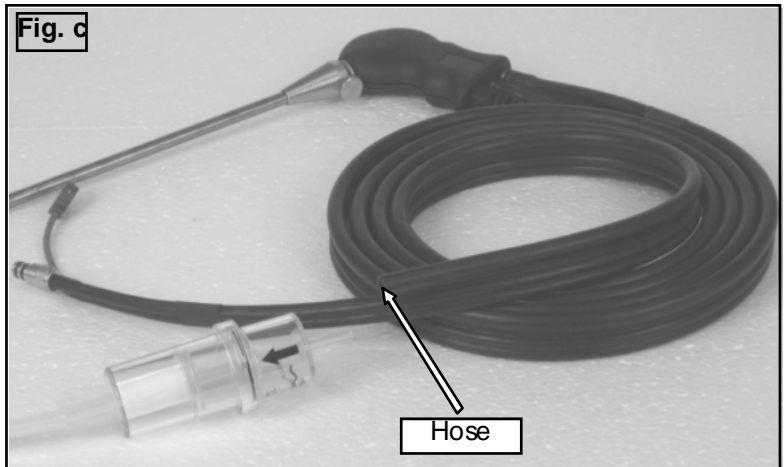
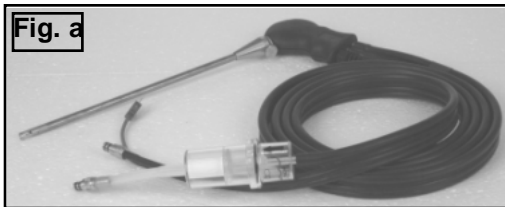

6.4 Maintaining the water trap / filter unit

To remove the water trap, just rotate the cover and unhook the filter holder body; remove the internal cup and then replace the filter (see figure on the side).

Clean all the filter parts using water only, dry the components and reassemble the filter.

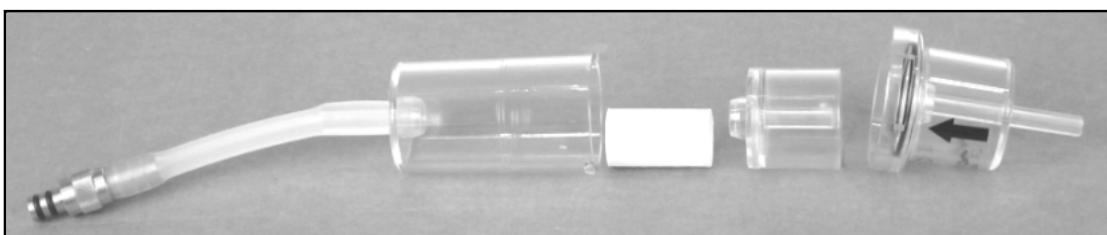

6.5 Replacing the particulate filter

If the particulate filter appears black, especially on the inner surface (see adjacent example), it has to be replaced immediately. In this way gas flow is not obstructed.

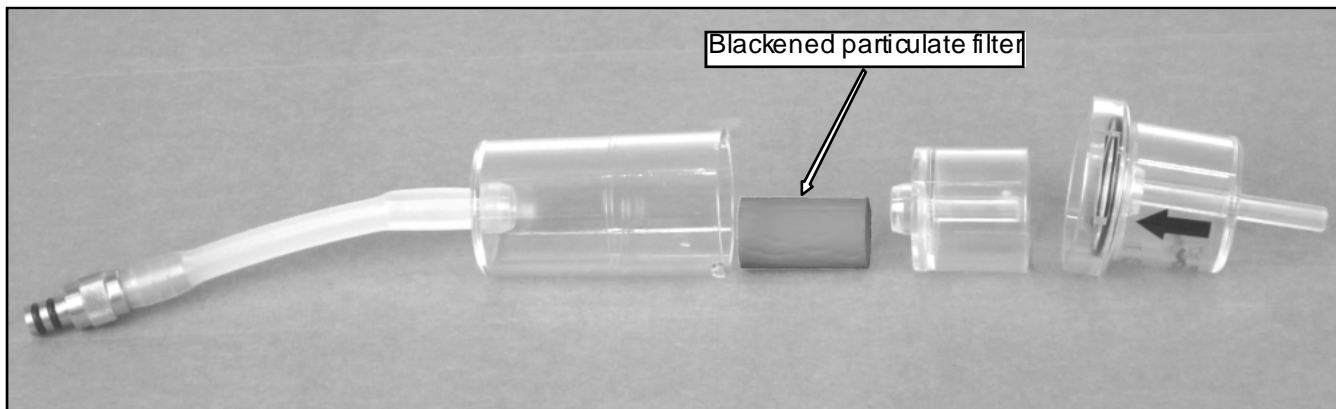

6.6 Replacing the gas sensors

The gas sensors of the instrument shall be periodically replaced (see the following table) with new or recalibrated sensors.

The user can easily perform this replacement operation according to the following instructions:

- 1 Undo the two fixing screws on the sensor compartment cover.

- 2 Remove cover to gain access to the sensor compartment, then grab the sensor assembly and carefully pull it out.

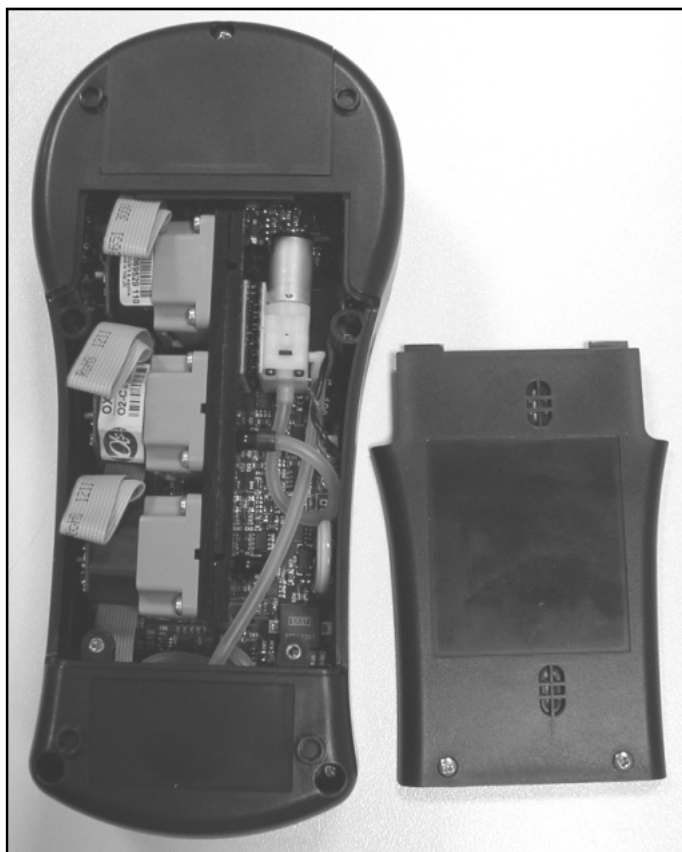
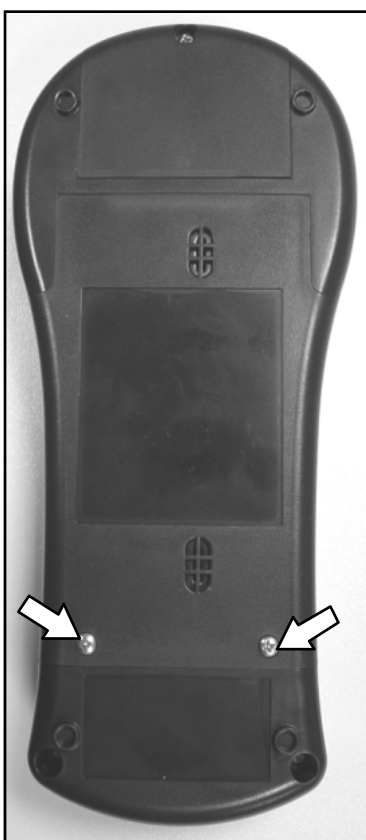

1

2

3

4

5

6

7

8

3 Locate the sensor to be replaced; here is an example of a connected sensor to be replaced.

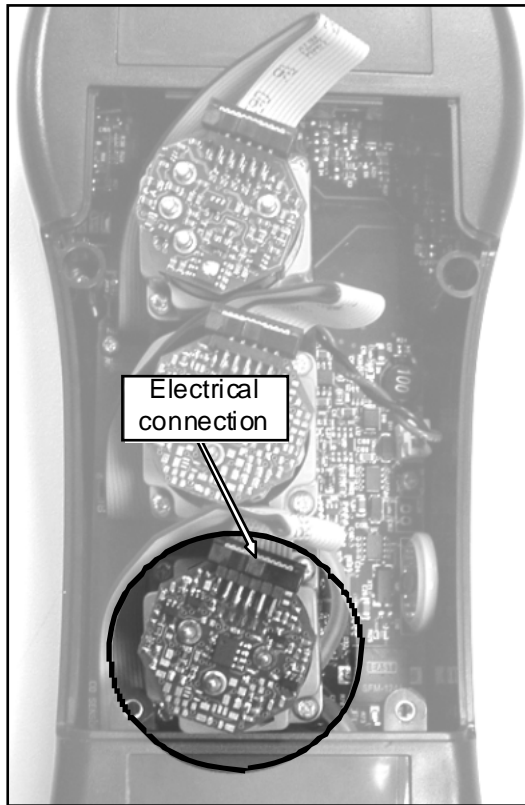

4 Disconnect the sensor to be replaced; here is an example of a disconnected sensor to be replaced.

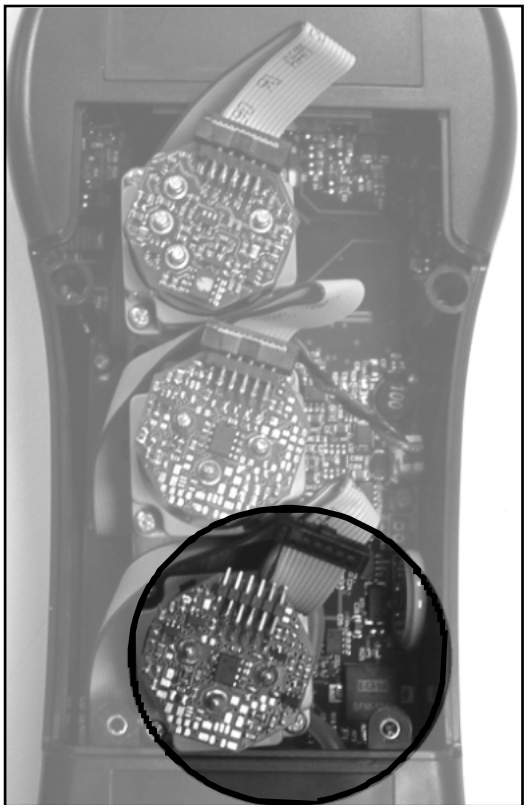

- 5 The sensor is bayonet-connected to its socket; rotate it counter-clockwise to remove it. Here is an example of a rotated sensor.

ATTENTION
 While rotating the sensor, take care not to exert any pressure onto the printed circuit above: apply pressure only onto the plastic body.

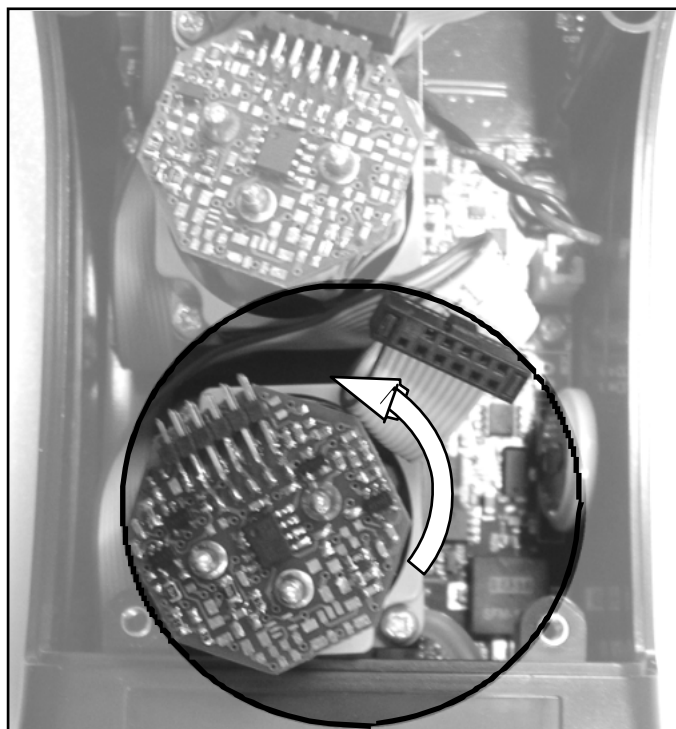

- 6 After rotating the sensor, pull it upward; here is an example of the sensor compartment with a sensor removed.

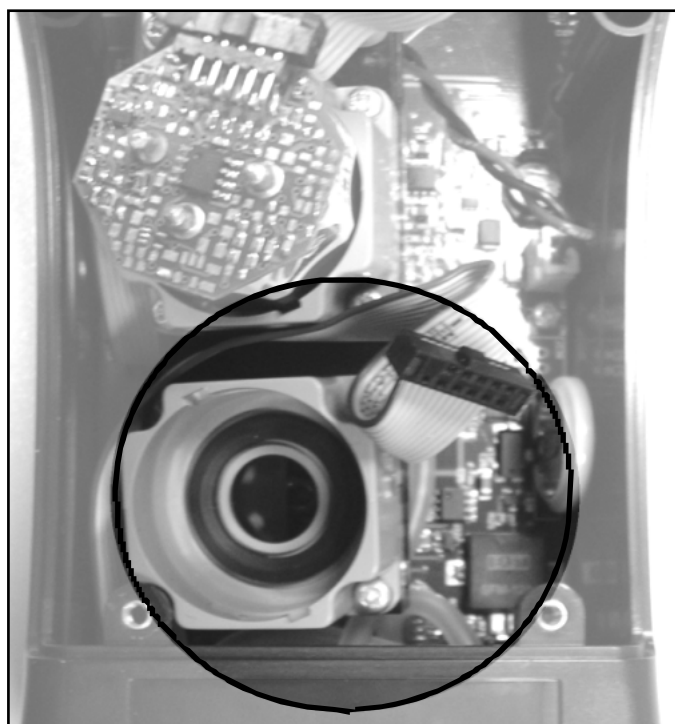

- 7 Fit the sensor again taking care the electric connection is turned outside the instrument, not inside (See point 5).

- 8 Rotate the sensor clockwise until you hear a click (See point 4).

ATTENTION

While rotating the sensor, take care not to apply any pressure onto the printed circuit above: apply pressure onto the plastic body only.

- 9 Reconnect the sensor (See point 3).
- 10 Close the back door of the sensor compartment again, and tighten screws again (See point 1).

Turn on the instrument to check the new sensor works correctly through the menu "Sensor Troubleshooting". It is normal if a newly installed sensor gives a 'current error': it is necessary to wait some time, so that the sensor polarization can settle. The table here below shows the minimum settling time for each sensor.

CODE	MEASURED GAS	POSITION	SETTLING TIME
FLEX-Sensor O₂ Cod. AAC SE15	O ₂ Oxygen	S1	2 hours ⁽¹⁾
FLEX-Sensor CO (Low H₂) Cod. AAC SE20	CO Carbon Monoxide	S2	2 hours ⁽¹⁾
FLEX-Sensor NO Cod. AAC SE10	NO Nitrogen Oxide	S3	48 hours ⁽²⁾

Note:

(1) 2-Hour settling time is required.

(2) 48-Hour settling time is required; should the sensor be equipped with an external polarisation battery, the settling time is reduced down to 2 hours.

6.7 On-site recalibration

It is possible to make a recalibration of the instrument's gas sensors with suitable known concentration gas cylinders. Recalibration of Oxygen (O₂) sensor is not available since it is already recalibrated during every autozero sequence.

The access to the sensor recalibration is password protected, the password is '1111'.

To carry on the recalibration the following instruments are needed:

- Known concentration gas cylinder suitable for the sensor, complete with a pressure regulator
- Flow meter
- Hose with Tee fitting to connect the cylinder to the flow meter and to the instrument

6.7.1 Flow Chart - On-site recalibration

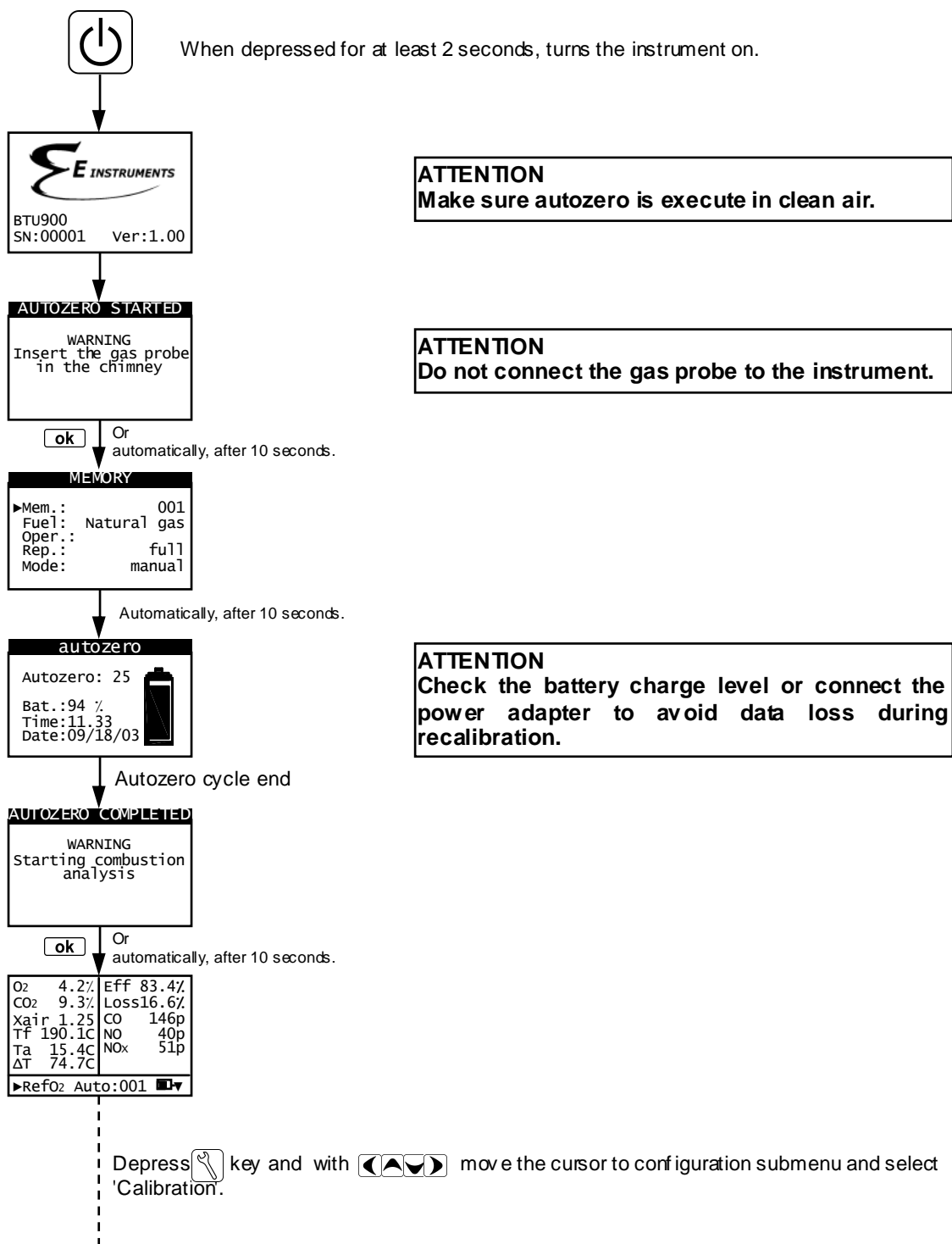

1

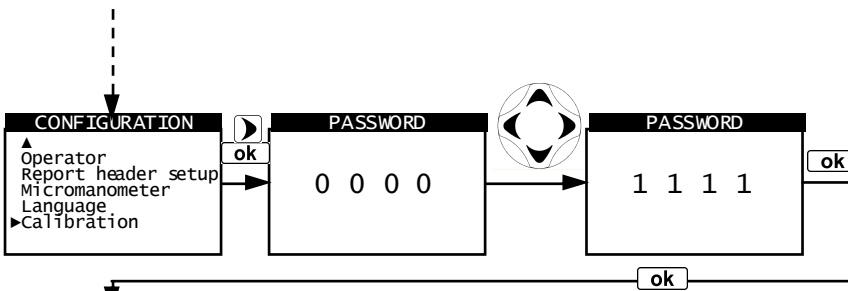

Enter the recalibration menu password **1111**.

2

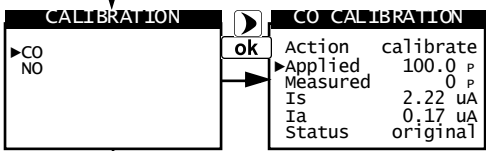

Installed sensors which can be recalibrated are shown, and can be chosen for recalibration. In recalibration screenshot, information about the calibration in use and sensor output are displayed.

3

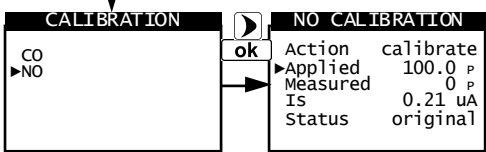

Action: selection of action to make
calibrate: save new calibration
set original: bring back factory original calibration
set user: bring back last user calibration done

4

Applied: selection of cylinder gas concentration
 Measured: Actual sensor reading
 Is: 'Is' current from the sensor
 Ia: 'Ia' current from the sensor
 Status: Shows calibration status:
original: factory original calibration in use
user: user calibration in use
saving: busy saving calibration
user cal OK: user calibration successful
cal error: user calibration error
orig cal ok: restore of original cal successful

5

CHOOSE THE SENSOR TO BE RECALIBRATED AND PROCEED AS DESCRIBED (CO SENSOR EXAMPLE):

- Connect the known concentration gas cylinder to the instrument as shown in the following scheme:

⚠ ATTENTION
 Adequate ventilation must be provided when working with toxic gases, particularly the flow meter and instrument outputs must be evacuated by a ventilation system.

6

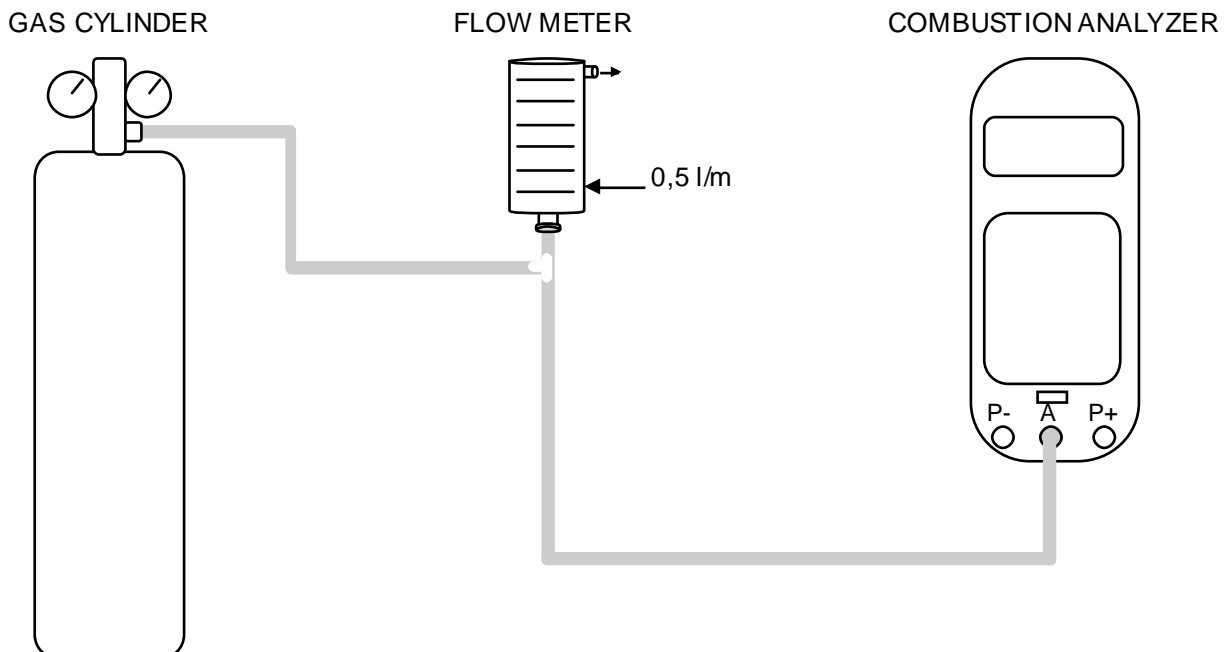

7

8

- Apply the gas to the instrument and regulate the cylinder output pressure so that the flow meter shows a minimum flow (0,5 l/m) this ensures that the instrument is getting exactly the gas needed by its internal pump.
- The instrument measures the concentration of the applied gas; **wait at least 3 minutes for the measure to stabilize**. The reading is shown in the 'Measured' row.

CO CALIBRATION	
Action	calibrate
▶Applied	1000.0 P
Measured	990.5 P
Is	82.22 uA
Ia	10.17 uA
Status	original

- Whenever the reading is not satisfactory, proceed with the recalibration; Select the concentration of the applied gas (cylinder concentration) in the 'Applied' row.

CO CALIBRATION	
Action	calibrate
▶Applied	1022.0 P
Measured	990.5 P
Is	82.22 uA
Ia	10.17 uA
Status	original

With  keys set the cylinder concentration in the 'Applied' row.

- Select 'Calibrate' in 'Action' row.

CO CALIBRATION	
▶Action	calibrate
Applied	1022.0 P
Measured	990.5 P
Is	82.22 uA
Ia	10.17 uA
Status	original

- Depress the '' key to save the new calibration.

CO CALIBRATION	
▶Action	calibrate
Applied	1022.0 P
Measured	990.5 P
Is	82.22 uA
Ia	10.17 uA
Status	cal ok

The recalibration result will be shown in the 'Status' row:
 'CAL OK': sensor recalibrated successfully
 'CAL ERROR': sensor not recalibrated due to:
 - The gas was not correctly delivered to the instrument.
 - The applied gas concentration was not correctly set in the 'Applied' row.
 - The 3 minutes stabilization time was not observed.
 - The sensor might be damaged or exhausted and needs to be replaced.

It is always possible to bring back the original calibration with the action 'set original' and bring back the last on-site calibration with 'set-user'.

1

6.8 Replacing the battery pack

Follow these instructions to replace the battery pack:

- 1 Undo the screw on the battery compartment cover and remove it .



- 2 Remove the battery pack.



2

3

4

5

- 3 Remove the battery pack connector, and replace the pack with a new one following the reverse procedure described above.



Battery pack connector



6

7

8

7.0 TROUBLESHOOTING

7.1 Troubleshooting guide

SYMPTOM	PROBABLE CAUSES AND REMEDIES
The instrument does not work at all. When the On/Off pushbutton is pressed the instrument does not come on.	<p>a. Keep the On/Off key depressed for at least 2 seconds.</p> <p>b. The battery is low; connect the battery charger to the instrument.</p> <p>c. The battery pack is not connected to the instrument; remove the cover from the battery compartment and connect the connector of the battery pack to the outlet on the printed circuit board.</p> <p>d. The instrument is faulty: send it to a service center.</p>
The battery symbol  is empty on the inside.	The batteries are low. The instrument will remain on for a couple of minutes after which it will switch off; connect the battery charger.
After auto-calibration is complete the sensor diagnostics screen appears and gives an error for one or more cells.	<p>a. Auto-calibration took place while the flue gas was being sampled.</p> <p>b. The O₂ sensor is faulty, is not connected correctly or is not connected at all. Check the above points, also referring to sections 5.3, 5.4, 6.6.</p> <p>c. The sensor was not allowed the necessary adjustment time or the instrument was left with a low battery for too long.</p>
A pressure sensor error is shown in the pressure/draft screen.	There is a calibration problem. Send the instrument to a service center.
The analysis screen gives a flue gas temperature (Tf) error.	<p>a. The thermocouple is not connected; connect the thermocouple to the analyzer.</p> <p>b. The sensor has been exposed to temperatures greater or lower than its operating temperature range.</p> <p>c. The thermocouple is faulty. Send the complete probe to a service center.</p>
The following symbol "----" appears on the analysis screen.	The instrument is not able to calculate a numerical value based on the flue gas analysis conducted. The "----" are replaced by numbers when the analyzer detects valid combustion data.
"Max. Lim." or "Min. Lim" appears on the analysis screen.	The relative sensor is detecting a value that is beyond the analyzer's measuring range. "Max. Lim" or "Min. Lim." are replaced by numbers when the instrument reveals values that are within the measuring range.
The sample pump sounds as though it is running slowly, tends to stop or does not even start.	<p>a. Sample flow is obstructed. Check that the water filter is clean and that it is not completely soaked. Also check that the hose connected to the probe is not crushed.</p> <p>b. Sample intake flow is obstructed. Check that the particulate filter is clean.</p> <p>c. The pump is not connected correctly. Remove the rear flap and check that the pump's electrical connector is connected to the printed circuit board.</p> <p>d. Pump is faulty. Replace the pump unit.</p> <p>e. Pump is disabled. The key combination   has been pressed. To re-enable the pump, switch off the instrument and then switch it on again.</p>

1

Troubleshooting guide

SYMPTOM	PROBABLE CAUSES AND REMEDIES
The rear lighting of the display is not on.	The backlighting LED's are faulty. Contact the nearest service center to replace the display.
The batteries last less than 9 hours.	<p>a. Battery capacity is limited by low temperatures. To achieve a longer battery life it is recommended to store the instrument at higher temperatures.</p> <p>b. The battery pack is old. Battery capacity tends to diminish with age. If battery life has become unacceptable, replace the battery pack.</p>
The values shown in the analysis screen are not reliable.	<p>a. Sensor/s is/are faulty. Check that the sensors are installed correctly by accessing the sensor diagnostics menu.</p> <p>b. The sample probe connection has a leak. Check all joints and the conditions of the hose.</p> <p>c. Pump is faulty. Replace the pump unit.</p> <p>d. The instrument is faulty: Send it to a service center for repair.</p>

2

3

4

5

6

7

8

8.0 SPARE PARTS AND TECHNICAL

8.1 Spare parts

- AAC BF01: Sensor junction block
- AAC FA01: Particulate filter
- AAC PB07: Li-Ion Battery pack - 7,4V 1,8Ah
- AAC SE15: FLEX-Sensor O₂, pre-calibrated and interchangeable
- AAC SE20: FLEX-Sensor CO (Low H₂), pre-calibrated and interchangeable
- AAC SE10: FLEX-Sensor NO, pre-calibrated and interchangeable

8.2 Accessories

- AAC AL04: 100-240V~/12 VDC 2A power supply with 2 m. cable
- AA CR03: Rigid plastic case
- AAC CT01: Shoulder bag
- AAC DP02: Deprimometer for Draft test
- AAC KP01: Differential pressure kit (set of 2 hoses + metal connectors)
- AAC PM01: Manual pump kit for smoke measurement + filters + Smoke chart
- AA SA05: Air temperature probe (cable length 3 m)
- AAC SF21A: 180 mm. gas probe, 1100°C extended temperature range, with 3 mt cable
- AAC SF22A: 300 mm. gas probe, 1100°C extended temperature range, with 3 mt cable
- AAC SF25A: 750 mm. gas probe, 1100°C extended temperature range, with 3 mt cable
- AAC SF26A: 1000 mm. gas probe, 1100°C extended temperature range, with 3 mt cable
- AAC SL02A: 220 mm. flexible gas probe, 1100°C extended temperature range, with 3 mt cable
- AA SM05: Protective Rubber Boot cover with magnets
- AAC SW04: Configuration software kit (USB flash drive + PC cable)
- AC ST02: External IR printer with battery charger.
- AAC TA03: Particulate/water filter assembly
- AAC TA03A: Particulate/water filter assembly with steel pipe and connector
- AAC UA02: Adapter cable USB-A / mini USB-B.
- AA RC04: Paper roll for printer, h=58 mm, diam.= 44 mm

8.3 Service Center

E Instruments International

172 Middletown Blvd.
Suite B201
Langhorne, PA 19047
USA

Tel.: (215) 750-1212

Fax.: (215) 750-1399

E-mail: Info@E-Inst.com

Website: <http://www.E-Inst.com>

