



SERIES 18/19/25

TEMPERATURE/PROCESS CONTROLLER



Instruction Manual

Introduction

Congratulations on your purchase of an Athena® Series 18/19/25 Single-Loop Controller. It is designed for ease of use and reliability wherever accurate closed-loop control is required. Your Series 18/19/25 has been configured according to your ordering specifications as either a universal process controller or a dedicated temperature controller. In addition, special functions such as a heater break alarm, digital communications, etc., do not require you to make any internal jumper or DIP switch settings..

After following the instructions for installation, simply step through and set your desired parameters using the controller's easy menu system. The instrument may then be automatically or manually tuned to your process for optimum setpoint control. A Quick-Start Reference Card is attached to the back of the instruction manual for experienced users of PID controllers. If you still have questions or require any assistance in setting up or operating your controller, please contact your Athena representative or call 1-800-782-6776.

Precautions

After unpacking, inspect the instrument for any physical damage that may have occurred in shipping. Save all packing materials and report any damage to the carrier immediately.

Safety Warning

In addition to presenting a potential fire hazard, high voltage and high temperature can damage equipment and cause severe injury or death. When installing or using this instrument, follow all instructions carefully and use approved safety controls. Electrical connections and wiring should be performed only by suitably trained personnel.

Do not locate this instrument where it is subject to excessive shock, vibration, dirt, moisture, oil or other liquids. Safe ambient operating temperature range is 32° to 131° F (0° to 55° C).

Table of
Contents

INSTALLATION	4
MOUNTING	5
WIRING	5
OPERATION	7
NOTES ON OUTPUTS	7
FRONT PANEL CONTROLS	8
PARAMETER MENU ORGANIZATION	9
SENSOR CONFIGURATION	11
AVAILABLE ALARMS	12
PARAMETER DESCRIPTIONS	12
TUNING PROCEDURES	15
SPECIAL FUNCTIONS	18
AUTO/MANUAL (STANDARD)	18
REMOTE SETPOINT SELECT	18
PROCESS VARIABLE RETRANSMISSION	20
HEATER BREAK ALARM	21
TRANSDUCER EXCITATION	22
LIMIT CONTROLLER OPTION	23
DIGITAL COMMUNICATIONS	26
RECALIBRATION PROCEDURE	30
ERROR CODES	30
WARRANTY/REPAIR INFORMATION	31
TECHNICAL SPECIFICATIONS	32
ORDERING CODES	33

Installation

Measurements between centerlines of panel cutouts are minimum recommended.

Figure 1. Recommended Panel Layout for Multiple Controllers

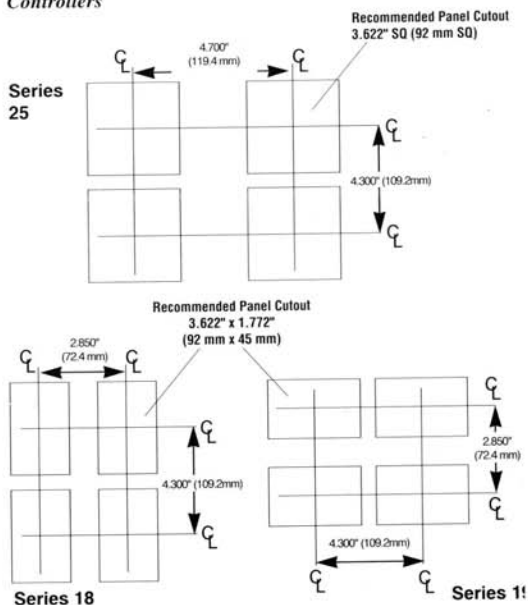

Note: Measurements between centerlines of panel cutouts are minimum recommended.

Figure 2. Case Dimensions

Prior to mounting the controller in your panel, make sure that the cutout opening is of the right size, and designed to enable a smooth fit. A minimum of 4" (100 mm) of depth behind the panel is required.

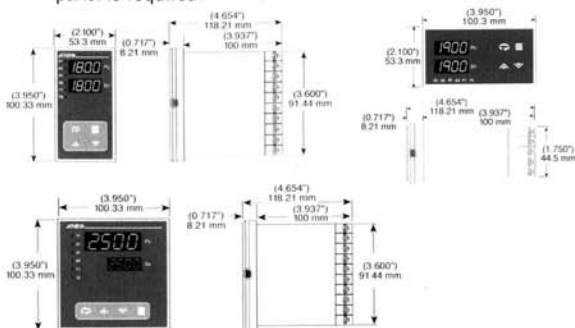
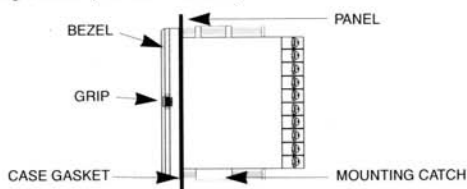

Figure 3. Series 18/19/25 Controller Mechanical Components (Series 25 shown)



Mounting

If the unit has been shipped with mounting catches already installed in the top and bottom slots in the case housing, they must be removed to allow insertion of the controller into the panel cutout.

Remove static-protective wrapping material from the instrument. Avoid inducing static charges to controller while handling and mounting. Insert the controller into the panel cutout from the front of the panel.

Place the mounting catches into the appropriate mounting slots at the top and bottom of the case housing and tighten the mounting screws to secure the controller firmly to the panel.

Note: For some panels, it may be necessary to first remove the controller chassis from the case housing to access the mounting catches from the inside. Press the grips on each side of the bezel firmly until the tabs release and slide the chassis out of the housing. Install the housing and secure it with the mounting screws to the panel. To re-insert the controller chassis back into its case, press both bezel grips simultaneously and slide the controller into the housing until the tabs engage.

Wiring

IMPORTANT: All electrical wiring connections should be made only by trained personnel, and in strict accordance with the National Electrical Code and local regulations.

The Series 18/19/25 controllers have built-in circuitry to reduce the effects of electrical noise (RFI) from various

kept separate and input leads should never be placed in the same conduit as power leads. We recommend separating connecting wires into bundles: power, signal, alarms and outputs. These bundles should then be routed through individual conduits. Shielded sensor cables should always be terminated at panel ground.

If additional RFI attenuation is required, noise suppression devices such as an R.C. snubber at the external noise source may be used. If you wish, you may order this suppressor directly from Athena, part number 235Z005U01.

Figure 4. Contact Identification

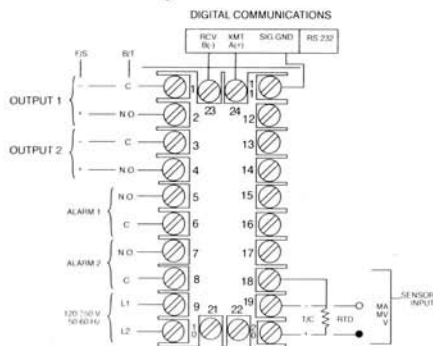

Sensor Input Connections

Thermocouple circuit resistance should not exceed 100 ohms for rated accuracy; errors will occur at higher resistance values. If shielded thermocouple wire is used, terminate the shield only at panel ground.

Use wire with a resistance no greater than 10 ohms. An error of 0.2° F will result for each additional 10 ohms of resistance encountered. If shielded RTD wire is used, terminate the shield only at panel ground.

Figure 5. Thermocouple Input Wiring

Make sure that you are using the appropriate thermocouple and extension wire. Connect the negative lead (generally colored red in ISA-type thermocouples) to contact #19; connect the positive lead to contact #20. Extension wires must be the same polarity as the thermocouple.

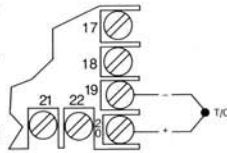
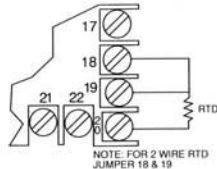

Figure 6. RTD Wiring

The controller accepts input from 2- or 3-wire, 100 ohm platinum resistance temperature detectors (RTDs). Connect 2-wire RTDs to contacts #19 and #20, with a jumper across contacts #18 and #19. Keep leads short and use heavy gauge copper extension wire, if necessary, to minimize lead resistance. For long runs, 3-wire RTDs should be used.



NOTE: FOR 2 WIRE RTD JUMPER 18 & 19

Figure 7. Process and Linear Input Wiring

Voltage Inputs: Connect the positive voltage input to contact #20; the negative input to contact #19. Current Inputs: Connect the positive current input to contact #20; the negative input to contact #19.

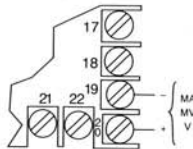

Power Wiring

The controller's standard power supply accepts 100 to 250 Vac and 130 to 330 Vdc line power without any switch settings or polarity considerations. All connections should be made in accordance with the National Electrical Code and local regulations, using only NEC Class 1 wiring for all power terminals.

It is advisable, but not necessary, to fuse one leg of the incoming power line, contact #9 or #10, with a 2AG, 0.5 amp rated fuse. *Be sure that only instrument power input is fused — not power to the load.*

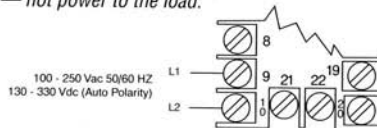

Figure 8. Power Wiring Connection

Operation

Throughout this manual, instructions that pertain solely to the process controller, as opposed to the temperature controller, are shown in blue.

Athena Series 18/19/25 Universal Controller

The Series 18/19/25 controller is an autotuning PID controller, which can function as either a temperature or linear process controller. (See pages 62-65 for specifications and ordering code).

Just a few steps are required before the instrument can be placed into service. After completing the mounting and wiring procedures as previously instructed, set your individual process parameter values by stepping through the setup menus, using the simple front-panel keys as instructed. Then, initiate the autotuning sequence as shown (or tune manually).

Notes on Outputs

When you ordered your controller, a specific output type was specified, designated as either "B", "E", "F", "S", or "T". You also had the option of configuring your controller with either one or two output actions. Generally, output 1 is a heat (reverse-acting) function and output 2 is a cool (direct-acting) function. For best results, follow the recommendations for setting cycle times for the output type supplied with your controller (see page 26). A brief description of output types follows:

Output Type	Description
B	5A/3A (120/240 Vac) relay, normally open, used for switching resistive loads. If relays or solenoids are to be driven, select the "T" output.
E	0-20 mA
F	4-20 mA, full output to load with 500 ohm impedance max. (suppressed).
S	20 Vdc pulsed output for solid-state relays.
T	1 A @ 120/240 Vac, solid-state relay, zero voltage-switched and optically isolated from drive signal. Only resistive loads to 1A may be controlled directly. Larger loads may be controlled using an external contactor.

Operation

Figure 9. Front Panel Controls and Indicators

Output 1

LED indication of Heat cycle (Output 1 action)

Output 2

LED indication of Cool cycle (Output 2 action)

Alarm 1

LED indication of Alarm1 condition

Alarm 2

LED indication of Alarm 2 condition

Function 1

LED indication of Special Function 1

Function 2

LED indication of Special Function 2

After mounting and wiring your controller, you are ready to set the parameter values required of your application. Take a moment to familiarize yourself with the unit's front panel controls and indicators.



Process Value

Displays measured process temperature in °F or °C or process value in engineering units

Setpoint Value

Displays programmed setpoint temperature in °F or °C or setpoint value in engineering units

Mode Key Used to access Standby, Tune, Run or Manual modes.

Lower Key Used to scroll down through available parameter settings, decrease values or change menu levels (Hold for fast-step progression)





Raise Key Used to scroll up through available parameter settings, increase values or change menu levels (Hold for fast-step progression)

Parameter/Access Key Used to index through parameters or to access Menu Levels

Operation

Power On



When power is first applied to the controller, both displays and all LED indicators are momentarily illuminated. The Process Value (PV) window then displays [-At-] or [-Ap-] and the Setpoint Value (SV) window displays an initialization code, e.g., [tt05]. The last two digits of this code indicate the software revision supplied with your controller. Please provide this revision number when contacting us regarding your controller. Depending upon whether Setpoint Target Time [SP.tt] is enabled, you may also see this symbol:  or . This means that the controller is ramping up or down to setpoint according to its previously programmed parameters. The default setpoint on initial power up is equal to the process temperature (process value). Before proceeding further, wait until the display has stabilized and then use the Raise  or Lower  keys to enter or adjust your desired Setpoint Value.

Parameter Menu Organization

The controller has five distinct menu levels. This enables quick access to relevant parameters without the need for scrolling through long menus. Menu "05" is used for



Operation

You cannot enter Standby Mode from menu level "00". Follow the instructions for changing menu levels to select another level.

initial controller configuration and menus "02" and "03" are used for setting or changing parameters. Menus "00" and "01" are used when the controller is in regular unattended operation and are not used for setting parameters. **For safety and security purposes, we recommend placing the controller in menu level "00" or "01" when in regular operation; however, it is not required.**

If you wish to "escape" from parameter selection within these menus at any time, simply press the Mode  key once. A description of the menu hierarchy and a detailed listing of menus and parameters begins on page 18.



Standby Mode StbY

When the controller is placed in Standby Mode, outputs are disabled; however, access is permitted to all menu levels and, unless the controller is at Run menu levels "00" or "01", operating parameters may still be changed. This mode is used for tuning the controller or entering Manual Mode. To enter Standby Mode, press and hold the Mode key  for four seconds until the lower window display flashes [StbY]. To exit Standby Mode from Menu Levels "01" to "05", press and hold the Mode  key for four seconds until the lower window display flashes [tUnE]. (If the Damping setting in menu "02" is [OFF], then Manual Mode will be activated and [HEAt] [OUT1] or [Cool] [OUT2] will be displayed with output percentage instead of [tUnE].





Operation

Press and hold the Mode key for four more seconds until the lower window returns to a steady display of Setpoint Value. (This procedure will not affect tuning). Removing power to the controller will also take the instrument out of Standby Mode.

Accessing Menu Levels RcCd

To access menu levels from Standby Mode from menu levels "02" to "05", press the Parameter/Access  key once. From menu levels "00" and "01", press and hold the Parameter/Access  key for approximately 4 seconds until the lower window display alternates between [Ac.Cd] and the menu level number last activated.

Changing or Displaying Menu Levels 05

To change menu levels, access the menu level display as instructed in the previous paragraph, then use the Raise  or Lower  key to set the desired menu level number. To display the current menu level setting in menu levels "02" to "05", from Standby press the Parameter/Access  key once. For menu levels "00" and "01", press and hold the Parameter/Access  key for approximately 4 seconds.







Operation

Because the controller's initial configuration affects other menu levels, it is important to set all required parameters in this menu first before accessing other menu levels.

Menu Level Descriptions

Menu "05" (Configuration Setup)

This is the menu level used for specifying initial configuration parameters before the controller is placed in Run mode.

After changing the access code to "05" as instructed in the previous paragraph, press the Parameter/Access  key to step through the various control parameters. Available parameters will flash in the lower window display, alternating with the current value for that parameter, each time the  key is pressed. To increase or decrease the value, simply press the appropriate Raise  or Lower  key, then press the  key to step to the next parameter. To exit the menu at any time, press the Mode  key. *Note: When programming in menu level "05", all outputs are disabled; however, any active alarms will remain active until the alarm condition is removed. New alarm conditions will not be recognized.*

Menu "04" (Communications and Calibration Setup)

This menu is used to set up the controller for digital communications and for recalibrating the controller when changing from thermocouple to RTD input, or vice versa. If your controller was ordered with the digital communications option, set these parameters next. To access this menu level, follow the instructions previously given.

Operation



Menu "03" (Alarm, Timing and Limit Setup)

In this menu, alarms, cycle times, setpoint target time and limits are established. After changing the access code to "03", press the Parameter/Access  key to step through the various parameters. To set or change parameter values, follow the instructions given previously.

Menu "02" (Control Mode)

Gain, Rate and Reset parameters are automatically set during autotuning. However, they can be manually adjusted by the operator. To return the controller to the Run mode, change the menu level access code back to "00" or "01" as previously shown.

Menu "01" (Run — Limited Access Mode)

The only parameter that can be changed at this menu level is the Setpoint Value, using the appropriate Raise  or Lower  key. To set or change other parameters, the operator must access another menu level by pressing and holding the Parameter/Access  key for 4 seconds.

Menu "00" (Run — Key Lock Mode)

In this menu, both display windows are illuminated; however, access is denied to all parameters. To set or change parameters, the operator must access another menu level as instructed previously.

Operation





The controller may be configured for various temperature ranges or process inputs, but the unit MUST be returned to the factory to change function from a temperature controller to a process controller, or vice versa.

Sensor Configuration

Temperature Controller

With the controller set to configuration menu level "05", press the Parameter/Access  key once. The lower display window will alternately flash [SnSr] and a code representing the input type, as follows:



c.A	K thermocouple
J	J thermocouple
t	T thermocouple
n	N thermocouple
r	R thermocouple
S	S thermocouple
PLII	Platinel II thermocouple
P	RTD
d	RTD (decimal range)

Press the Parameter/Access  key until [Unt] is displayed and select either Fahrenheit or Celsius using the appropriate Raise  or Lower  key to toggle between them. Press the Mode  key to return to the setpoint display.





Operation

Input Configuration

Process Controller

With the controller set to configuration menu level "05", press the Parameter/Access  key once. The lower display window will alternately flash [Sn.00] and a code representing suppressed [SU] or unsuppressed [U.SU]. Use the appropriate Raise  or Lower  key to select your preference.

Press the Parameter/Access  key until [FILt] is displayed and select your desired digital filtering constant (0.1 sec, 1.0 sec, 10 sec), using the Raise or Lower keys to scroll through the selections.

Press the Mode  key once and then the Parameter/Access  key to return to the menu access level and use the Lower key  to change to menu level "03". Press the Parameter/Access key again until Low Scale Setting [L.SCL] flashes. Select the desired low scale setting, from -1999 to 9999, using the appropriate Raise or Lower key. Press the Parameter/Access key again until the High Scale Setting [H.SCL] flashes. Select the desired full scale setting, from -1999 to 9999, using the appropriate Raise or Lower key. Press the Mode  key to return to the setpoint display.

Operation

Available Alarm Types [A1.P.d.] [A2.P.d.]

Selectable at menu level "05", as either Process [Pr] or Deviation [dE] and either high or low [A1.HL] or [A2.HL].

Process Alarm: Activates at preset value independent of setpoint. "High" process alarm activates at and above alarm setting. "Low" process alarm activates at and below alarm setting.

Deviation Alarm: Activates at a preset deviation value from setpoint. "High" or "Low" deviation alarm activates above or below setpoint according to the preset deviation value.

When a latching alarm has been activated and the alarm condition has been removed, the Mode  key must be pressed to unlatch the alarm.

Latching Alarms

The alarms may also be configured as latching alarms by selecting "LAT" in the [A1.O.P.] or [A2.O.P.] parameter selection at menu level "05".



Parameter Descriptions

Figure 11. Temperature Controller Menu Hierarchy

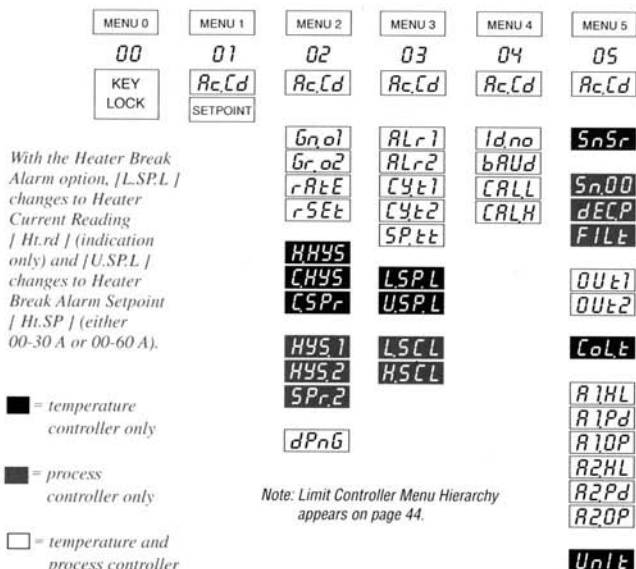

Parameter Descriptions

Series 18/19/25 Temperature/Process Controller

Menu "05"

Display	Parameter	Selection	Code
SnSr	Sensor type	Thermocouple:	
		K	c.A
		J	J
		N	n
		R	r
		T	t
		S	S
		RTD	P
		RTD (decimal range)	d
		Platinel II (special)	PI
OU1	Output 1 action	Heat PID	Ht.P
		Heat On/Off	Ht.O
OU2	Output 2 action	Cool PID	CL.P
		Cool On/Off	CL.O
Sn.00	Input Zero Level	0-20 mA	U.SU (Unsuppressed)
		4-20 mA	SU (Suppressed)
dEC.P	Decimal Point		999, 99.9, 9.99
FILt	Digital Filtering		0.1, 1, 10
OU1	Output 1 action	PID	Pid
		On/Off	On.F
OU2	Output 2 action	PID	Pid
		On/Off	ON.F

The Digital Filtering setting [FILt] on the process controller allows the operator to compensate for noise which may cause the last digits of the PV display to become unstable. Sampling rate is not affected. The settings are time constants, in seconds, with 0.1 equivalent to "no filtering."

Parameter Descriptions

CoL.t*	Cooling type	Water	H2o (non-linear output)
		Normal	nor (linear output)
A1.H.L.	Alarm 1 select	Low/High	Lo/HI
A1.P.d.	Alarm 1 type	Process/Deviation	Pr/dE
A1.O.P.	Alarm 1 output	Off/Normal/Latching	OFF/nor/LAT
A2.H.L.	Alarm 2 select	Low/High	Lo/HI
A2.P.d.	Alarm 2 type	Process/Deviation	Pr/dE
A2.O.P.	Alarm 2 output	Off/Normal/Latching	OFF/nor/LAT
Unlt	Measurement units	*F or °C	F/C

* For water-cooled extruders, select H2o.

Menu "04"

Display	Parameter	Allowable Values
Id.no	Device ID number (remote communications)	00 to 99
bAUd	Baud, parity and data bit selection	See chart below
CAL.L	Calibration low	Preset at factory
CAL.H	Calibration high	Preset at factory

Available Communications Settings

Display	Description			
	Baud Rate	Parity	Data Bits	Stop Bits
3.o.7	300	odd	7	2
6.o.7	600	odd	7	2
12.o.7	1200	odd	7	2
24.o.7	2400	odd	7	2
3.n.8	300	none	8	1
6.n.8	600	none	8	1
12.n.8	1200	none	8	1
24.n.8	2400	none	8	1

Parameter Descriptions

Setting output cycle time to "00" initiates a 200 ms timebase. A cycle time setting is required for smooth proportional action. Too long a setting may cause proportional ripple; too short may decrease relay contactor life.

When changing thermocouple types, be sure to check/adjust upper and lower setpoint limit values.

Menu "03"

Display	Parameter	Allowable Values
ALr1	Alarm 1 setting	Dependent on sensor range
ALr2	Alarm 2 setting (if ordered)	Dependent on sensor range
CY:t1	Cycle time output 1	00 to 120 seconds
CY:t2	Cycle time output 2	00 to 120 seconds
SP:tt	Setpoint target time (ramp-to-setpoint)	Off/1 to 100 minutes
L.SP.L	Lower setpoint limit	Dependent on sensor range
U.SP.L	Upper setpoint limit	Dependent on sensor range
L.SCL	Low scale setting	-1999 to 9999
H.SCL	High scale setting	-1999 to 9999
Output Type	Recommended Setting (seconds)	
B (5A/3A)	15 to 120	
E (0-20 mA)	00	
F (4-20 mA)	"00"	
S (pulsed 20 Vdc)	00 to 120	
T (S.S. relay)	15 to 120*	

*Note: Shorter cycle times may be used when driving heater loads directly.

Notes on Setpoint Target Time: The [SP:tt] parameter allows the operator to enter a time delay for the process to reach setpoint temperature (ramp to setpoint), from disabled [OFF] or 1 to 100 minutes. When enabled, the ramp sequence starts on power-up. The ramp-to-setpoint feature will also be initiated whenever a new setpoint target time is entered AND the Setpoint Value is 5° F or more from the current process temperature. In operation, the controller's lower window display will flash [] or [] to indicate that it is "ramping" up or down to setpoint. The Setpoint Value cannot be changed during this procedure. After it is finished, the operator can adjust the setpoint temperature to the desired value.

While in ramp startup, the ramp-to-setpoint mode can be aborted and the controller returned to regular operation by pressing the Parameter/Access key until parameters are displayed and then pressing the Mode key once.

Parameter Descriptions

Setting Rate (Derivative) or Reset (Integral) to [00] disables that aspect of PID control.

The ratio of rate-to-reset is limited to a minimum of 1:4, i.e., Reset value cannot be set any lower than four times Rate.

The parameters of Heat Hysteresis, Cool Hysteresis and Cool Spread are only available when Output 1 and/or Output 2 are set to on/off mode [Ht.O] or [CLO]. They replace Gain Output 1 and Gain Ratio Output 2, respectively.

Menu "02"

Display	Parameter	Allowable Values
Gn.01	Gain Output 1 (PID heat gain)	00 to 400 (This value may exceed 400 as a result of auto-tuning.)
Gr.02	Gain Ratio Output 2 (PID cool gain ratio)	0.0 to 2.0
H.HYS	Heat Hysteresis	01 to 100°
C.HYS	Cool Hysteresis	01 to 100°
HYS1	Output 1 Hysteresis	1 to 100 units
HYS2	Output 2 Hysteresis	1 to 100 units
SP:r2	Spread Adjustment, Output 2	0 to 100 units
C.SP.r	Cool Spread	0 to 100°
rAIE	PID rate	00 to 900 seconds
rSEt	PID reset	00 to 3600 seconds
dPnG	Damping (see notes)	Lo, nL, Hi, Off

Notes on Damping: The damping parameter is an autotune feature that enables more precise control of setpoint overshoot during recovery from process upsets in which thermal or transfer lag is a factor. See Figure 12. Use the correct setting prior to autotuning to compensate for power and load/sensor coupling characteristics.

Lo = Fast recovery with slight overshoot. For single-lag processes.
Ex. Adequate power and excellent load/sensor coupling.

nL = Normal recovery with no overshoot. For two-lag processes.
Ex. Properly sized heaters or components and good load/sensor coupling.

Hi = Slow recovery with no overshoot. For three-lag processes.
Ex. Overpowered with multiple lags. Poor load/sensor coupling.

OFF = Autotune disabled; manual output control enabled.

Parameter Descriptions

Figure 12. Typical Lag Processes

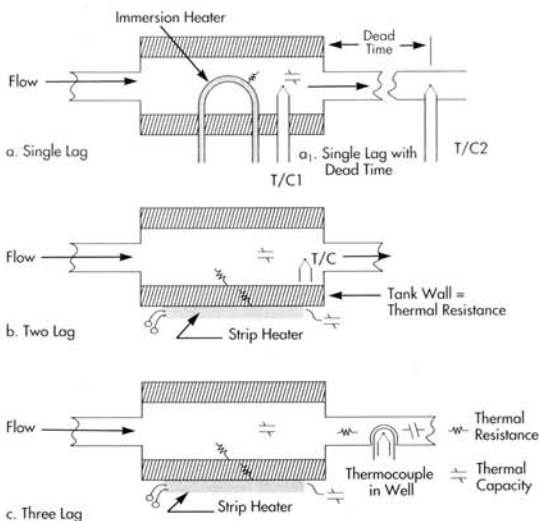

Tuning Procedures

For best results in tuning the temperature controller, the setpoint value should be at least 100°F above or below ambient temperature.

While some processes other than heat or cool applications may respond successfully to autotuning procedures, the controller must be manually tuned for most non-temperature processes.

The Series 18/19/25 is an "on demand" autotuning controller that automatically sets PID parameter values (Proportional Band, Reset and Rate) before the process reaches setpoint. A damping setting (menu level "02") MUST be selected for autotuning to take place. (see *Notes on Damping*, page 27). The controller may also be tuned manually (see page 32).

Autotuning the Temperature Controller

- 1) With the power off and the process at ambient, apply power and immediately put the controller in Standby mode by holding the \equiv key for four seconds until [StbY] flashes in the lower display window. If controller is in menu level "00" or "01", hold the Parameter/ Access \curvearrowright key for 11 seconds until [Ac.Cd] appears. Then change to menu level "05".
- 2) Press the \curvearrowright key once and use the \blacktriangle key to select menu level "05".
- 3) Enter the desired Setpoint Value using the appropriate Raise \blacktriangle or Lower \blacktriangledown key. [StbY] will continue to flash.
- 4) Press the Parameter/Access \curvearrowright key twice until [SnSr] is displayed to make sure that the proper sensor has been selected. Then set the controller's heating mode by pressing the Parameter/Access \curvearrowright key again until [OUT1] is displayed. (If you scroll past it, just continue scrolling until the parameter menu repeats.) Using the appropriate Raise

Tuning Procedures

▲ or Lower ▼ key, select the one of the following settings according to the requirements of your process.

Note: For autotuning, at least one output MUST be set to PID mode.

Mode	Output 1 (Heat) Setting	Output 2 (Cool) Setting
PID	[Ht.P]	[CL.P]
On/Off	[Ht.O]	[CL.O]

Press the Parameter/Access ↻ key again to step to output 2 [OUT2]. Repeat the selection process for cooling mode. If only one output is PID, set the other output to On/Off.

- 5) Press the Parameter/Access ↻ key again to display the Cooling Type parameter [CoL.t], and select either Normal/Linear output [nor] or Water-Cooled/Non-Linear output [H2o].
- 6) Exit menu level "05" by pressing the Mode ≡ key once. The lower window will flash [StbY]. Now press the Parameter/Access ↻ key once. The lower window will display [Ac.Cd] and [05]. Press the Lower ▼ key twice to select menu level "03".
- 7) Press the Parameter/Access ↻ key and select Cycle Time for Output 1 [CY.t1] and Cycle Time for Output 2 [CY.t2]. For Control Output type B or T, enter "15". For Control Output type E, F or S, enter "00".
- 8) Press the Parameter/Access key until Setpoint Target Time [SP.tt] is displayed. Select [OFF].

Tuning Procedures

Before autotuning can take place, you must select a damping setting. If the damping parameter does not appear on the menu, you have not selected a PID option for outputs 1 or 2. Refer back to step (4) and select the proper setting(s).

During autotuning, the process temperature will gradually cycle from ambient to setpoint. When autotuning is complete, the [tUnE] display will stop flashing and the Gain, Rate and Reset numbers "learned" will be kept in memory for subsequent startups.

- 9) Press the Mode ≡ key once. The lower window will again flash [StbY]. Press the Parameter/Access ↻ key once and the lower window will display [Ac.Cd] and [03]. Press the Lower ▼ key once to select menu level "02".
- 10) Press the Parameter/Access ↻ key and scroll through the displayed parameters. If Gain Ratio [Gr.o2] is displayed, set it to [1.0]. Otherwise, continue scrolling until [dPnG] appears. Set Damping initially to Normal [nL]. (This setting may have to be changed later. See *Notes on Damping*, page 28).
- 11) Press and hold the Mode ≡ key until [tUnE] flashes in the lower display window. The controller is now autotuning. When it stops flashing, the autotuning procedure is completed and the controller is ready for your process. As a security measure, you may wish to place the controller in Key Lock "00" or Limited Access "01" Run mode by changing menu levels as instructed previously.

Autotuning will not function when process is at setpoint.

Figure 13. Typical "Autotune" Temperature Profile.

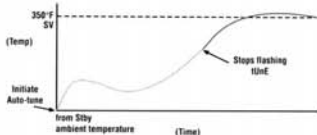

Tuning Procedures

If overcooling exists on heat/cool processes after autotuning, decrease Gain Ratio [Gr.o2] in steps of 0.1 until oscillation is minimal. If cooling is sluggish, increase the value in steps of 0.1 until optimum results are achieved.

Gain ratio [Gr.o2] is the cooling gain expressed as a factor of the heating gain.

Ex. [Gn.o1] = 100
[Gr.o2] = .5
Cooling Gain = 50

Tuning Procedures

Calculate and enter these numbers:
Rate [rAtE] = T/8
Reset [rSEt] = rate x 4
Gain [Gn.o1] = Step (15) x 0.6

Manual Tuning Procedure - Temperature Controller (Zeigler-Nichols PID Method)

This tuning method may be used if the spread between ambient temperature and process operating temperature is small. For best results, the use of a recording device is suggested when tuning with this method.

- 1) Disable any cooling device used.
- 2) Apply power and place the controller in Standby by pressing and holding the Mode \equiv key for four seconds.
- 3) Access menu level "02" following instructions given previously.
- 4) Using Raise \blacktriangle or Lower \blacktriangledown key, adjust setpoint to desired value.
- 5) Using the Parameter/Access \curvearrowright key, index to Heat Gain [Gn.o1]. Select [01].
- 6) Index to Gain Ratio [Gr.o2] and select [1.0].
- 7) Index to Rate [rAtE] and select [00].
- 8) Index to Reset [rSEt] and select [00]. Note: In order to set Reset to [00], Rate must first be set to [00].
- 9) Change to menu level "03".
- 10) Index to Cycle Time 1 [CY.t1] and select the timebase, in seconds, appropriate to the device being controlled. (See note on page 27.)

- 11) Repeat for Cycle Time 2 [CY.t2].
- 12) Change to menu level "05".
- 13) Set Cooling Type [CoL.t] to [nor].
- 14) Press the Mode \equiv key once. Setpoint Value will be displayed. The recording device should now be tracking process temperature.
- 15) Double the Gain [Gn.o1] until a small, sustained oscillation is visible on the recording device's trace.
- 16) Measure the period of one cycle of oscillation ("T" on the diagram below).

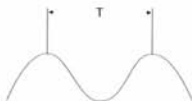

- 17) Divide the period of oscillation (T) by eight (8). The resulting number is the correct Rate time [rAtE] in seconds. Multiply this number by four. This is the correct Reset time [rSEt] in seconds.
- 18) Multiply the gain (from step #15) by 0.6 and enter this number as Gain [Gn.o1].
- 19) Enable the cooling device. If overcooling exists, decrease the Gain Ratio [Gr.o2] in steps of 0.1 until temperature oscillation stops. If cooling is sluggish, increase the Gain Ratio in steps of 0.1 until optimum results are achieved.

Tuning Procedures

Manual Tuning Procedure - Process Controller (Zeigler-Nichols PID Method)

A chart recorder to monitor the process variable is required. The controller must be properly scaled and filtering set as instructed previously.

- 1) Apply power and place the controller in Standby by holding the Mode \equiv key for four seconds.
- 2) Access menu level "05" and select one output: [OUT 1] for reverse-acting control or [OUT 2] for direct-acting control. Set the active output to PID [Pid] and the unused output to On/Off [On.F].
- 3) Adjust the setpoint to the desired value.
- 4) Access menu level "02" and set [Gn.01] to 1.0; [Gr.o2] to 1.0; and [rAtE] and [rSEt] to "00".
- 5) Press the Mode \equiv key for four seconds until display flashes [tUnE]. Press the Mode key for another four seconds and the process will run in closed loop mode.
- 6) While monitoring the chart, increase Gain [Gn.o1] by doubling the gain number until the process variable becomes unstable. Then decrease Gain until the process oscillations are sustained, neither increasing nor decreasing in amplitude as a result of momentary setpoint change.
- 7) Measure the period of one complete cycle of oscillation, "T", in seconds.
- 8) Multiply the Gain from Step (6) by 0.6 and enter as Gain value.

Calculate and enter these numbers:

Rate [rAtE] = $T/8$
Reset [rSEt] = $T/2.0$
Gain [Gn.01] = Gain from Step (8)

On noisy processes, where Rate cannot be used:
Gain [Gn.01] = from Step (8) $\times 0.45$
Reset [rSEt] = $T/1.2$

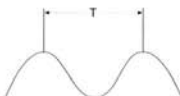

Special Functions

In manual control mode, error conditions such as A/D errors and open or reversed sensors will be ignored.

Auto/Manual Operation (Standard)

To put the controller in manual mode, set the damping [dPnG] parameter in menu level "02" to [OFF]. Press and hold the Mode \equiv key for four seconds until the lower display window flashes [StbY]. Hold down the Mode key for another four seconds to initiate manual operation. The lower display window will flash PID output as a percentage of output power, from 100 to -100, alternating with the output controlled (temperature controllers will flash [HEAt] or [CoOL], process controllers will flash [OUT1] or [OUT2].) To take the controller out of manual mode, press and hold Mode \equiv key to four seconds.

Remote Setpoint Option

If your controller was ordered with this option, you may select either of two setpoints for your process. The second setpoint can be enabled only by an external switch or signal, according to your ordering specifications. The "F2" LED on the front panel will illuminate when a second setpoint is selected. If you do not know how your controller was configured, refer to the ordering code and description on page 65.

Special Functions

When installed, this option provides the user with a method of inputting several types of analog signals to the controller, typically 1-5 volts or 4-20 milliamps, although it is also capable of 0-5 volts or 0-20 milliamps in the unsuppressed mode.

The primary purpose of this feature is to provide an auxiliary analog Second Setpoint function for control of Setpoint Value by remote computer, analog potentiometer or other source. The analog input value replaces the primary digital (front panel keyed-in value) when the switch input associated with the module is closed. The option also provides a 5 volt excitation for the remote potentiometer (see wiring diagram).

OPTION ORDERING CODES

SA¹ Switch Closed & 0-5 V dc or (500 - 10 Kohm) Potentiometer signal input

SB² " " " 1-5 V dc

SC² " " " 0-20 mA dc

SD² " " " 4-20 mA dc

The above options require an external switch on pins 14 & 15 and a remote signal on pins 12 & 13, to change to the second setpoint value.

SE Second Setpoint Switch (front panel)

¹ INPUT IMPEDANCE= 20K ohms

² INPUT IMPEDANCE = 250 ohms

Special Functions

Figure 14. Wiring Diagram for Remote Setpoint Select Option

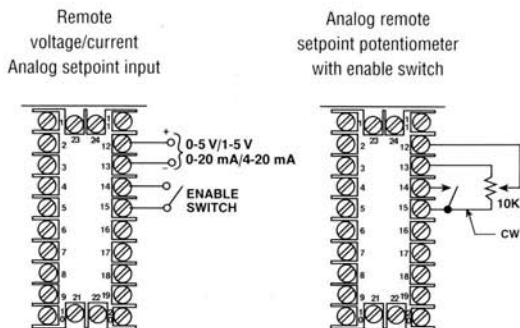

Special Functions

These output values are linear with and dependent upon the sensor being used, i.e., the lowest value of the sensor's output range corresponds to zero or low for the output function.

Process Variable Retransmit

Retransmit Signal is the retransmission of the process variable (PV) signal out to an external device:

- *Chart Recorder
- *Indicator
- *Process Controller
- *Data Logger

Generally, the main purpose of the retransmit signal is for keeping a log of data information with respect to time. It is not a scaleable parameter, but rather a variable process signal, dependent on sensor type.

This option provides the user with the capability to attach auxiliary equipment, such as chart recorders, computers, etc. The outputs are:

- suppressed— 1-5 Vdc/4-20 mAdc
- unsuppressed — 0-5 Vdc/0-20 mAdc

They correspond to the zero and full scale values of the range selected.

Example: "J" couple = 0 to 1400 degrees F
Output = 0-5 Vdc/0-20 mAdc unsuppressed
 1-5Vdc/4-20 mAdc suppressed
0 degrees F = 0 Vdc/0 mAdc-unsuppressed
 1 Vdc/4 mAdc-suppressed
1400 degrees F = 5 Vdc/20 mAdc

Special Functions

Note: In degrees Celsius mode there will be a shift, as follows:
(The lowest value of the range is the zero output for the output function)

"J" couple = -18 to 760 degrees C
Output -18 degrees C = 0 Vdc/0 mAdc-unsuppressed
 1 Vdc/4 mAdc-suppressed
760 degrees C = 5 Vdc/20 mAdc

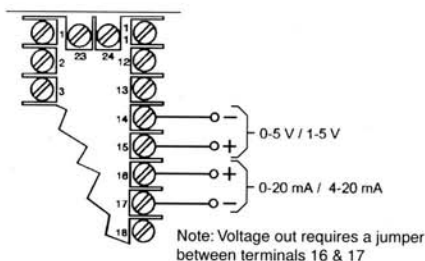

Figure 15. Wiring Diagram for Process Variable Retransmission

SPECIFICATIONS

- I out (current output) = 0-20 mA / 4-20 mA
- Voltage Headroom = 8 Vdc- standard
- = 18 Vdc - for multiple chart recorders optional
- V out (voltage output) = 0-5 Vdc / 1-5 Vdc
- I out MAX = 20 mA
- Output Impedance = 255 ohms max.

Special Functions

The Heater Break Alarm option is not available on controllers with an "F" type output.

With the Heater Break Alarm option, cycle time is limited to greater than 2 seconds.

HEATER BREAK ALARM

The Controller compares a sensor input signal with the Setpoint and makes a power calculation, which produces an output signal to the load.

The Heater Break Alarm (HBA) detects failures in the load and provides an alarm output.

HBA uses an external current transformer to monitor the load current. If the load current should fall below a set current value, an alarm output will activate.

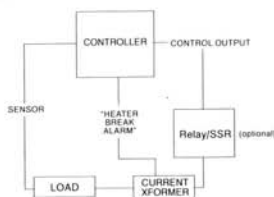
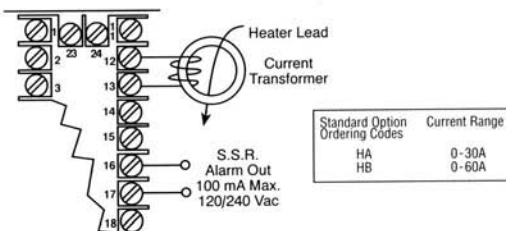
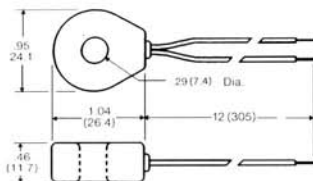

Figure 16. Wiring Diagram for Heater Break Alarm



Special Functions

Figure 17. Current Transformer (Can Be Supplied with Heater Break Alarm Option, Part # 580E023UOI)



SPECIFICATIONS

.29" DIA. OPENING

INDICATING RANGE: 2 thru 100 A

MAX. CONT. CURRENT: 100 A

MAX. TRANSIENT CURRENT: 150 A for 5 sec.

WORKING CLASS: 600 • FREQUENCY: 50-60 Hz

WEIGHT: .5 Oz (14 grams)

LEAD WIRE: #22 AWG UL Style 1213

CASE COLOR: Black • CASE MATERIAL: Thermoplastic

Remote Current Transf.: Indicating Range : 2-100 A

Working Class : 600 volts, 50-60 Hz

Max. Transient Current: 150 A for 5 seconds

Special Functions

Transducer Excitation

The transducer excitation voltage option is used to produce a constant dc voltage of 10, 12 or 15 Vdc out to an external device, eliminating the need for an additional external power supply. Refer to the ordering code if you do not know which voltage output was specified.

Option	Ordering Code	Voltage Output
	1	10 V
	2	12 V
	3	15 V

Maximum Current = 22 mA

Figure 18. Wiring for Transducer Excitation Output

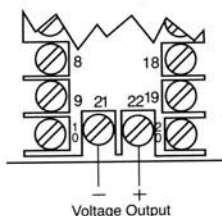

Special Functions

Figure 18a. Wiring Diagram for 2-Wire Sensor Input with Transducer Excitation Option

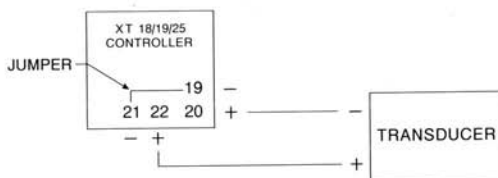

MAXIMUM CURRENT = 22 mA
 OUTPUT VOLTAGES = 10, 12 and 15 Vdc
 AMBIENT TEMP = 32-131° F, 0-55° C

Limit Controller Option ED

Series 18/19/25 Limit Controller Menu Hierarchy

MENU 0	MENU 1	MENU 2	MENU 3	MENU 4
00	01	02	03	04
KEY LOCK	RcCd SETPOINT	RcCd	RcCd	RcCd
		RLSP	Idno	IntP
		SPLo	bAUd	LItP
		SPHI	CALL	RLtP
			CALH	RLSL
				RLot
				oPSL
				dECP
				FILt
				UnIt

Limit Controller Option ED

Parameter Descriptions

Menu "04"	Parameter	Selection	Code
Display			
IntP	Sensor type	Thermocouple Platinel II S T R N J K RTD RTD (decimal range) Platinel II (special)	PLII S t r n J c.A P d PI
LItP	Limit type	High Limit Low Limit	HI Lo
ALtP	Alarm type	Process/Deviation	Pr/dE
ALSL	Alarm select	High/Low Alarm	HI/Lo
ALot	Alarm output	Normal/Latching (Not Functional)	nor/LAt 00
oPSL		(Not Functional)	00
dECP	Decimal point	(Not Functional)	02/01/00
FILt	Digital filtering		10.0/1.0/0.1
UnIt	Measurement units	F-deg or C-deg	F/C

Limit Controller Option ED

Parameter Descriptions (continued)

Menu "03"

Display	Parameter	Allowable Values
Idno	Device ID number (remote communications)	00 to 99
bAUD	Baud, parity and data bit selection	See next page under the heading of "Available Communications Settings"
CALL	Calibration low	Preset at factory
CALH	Calibration high	Preset at factory

Limit Controller Option ED

Parameter Descriptions (continued)

Menu "02"

Display	Parameter	Allowable Values
ALSP	Alarm setpoint	0 to 8191
SPLo	Setpoint low (lower setpoint limit)	Dependent on sensor range
SPHi	Setpoint high (upper setpoint limit)	Dependent on sensor range

Available Communications Settings

Display	Description			
	Baud Rate	Parity	Data Bits	Stop Bits
24.n.8.	2400	none	8	1
12.n.8.	1200	none	8	1
6.n.8.	600	none	8	1
3.n.8.	300	none	8	1
24.o.7.	2400	odd	7	2
12.o.7.	1200	odd	7	2
6.o.7.	600	odd	7	2
3.o.7.	300	odd	7	2

Limit Controller Option ED

Operation

High Limit Operation — During normal operation the mechanical relay in output “1” is closed. If the process temperature exceeds the high limit setting, then the mechanical relay in output “1” will open (“01” LED is now lit) cutting off power to the load. When the process temperature drops back down to below the limit setting, output “1” will remain open until you press the mode key to reset the controller.

Low Limit Operation — During normal operation the mechanical relay in output “1” is closed. If the process temperature drops below the low limit setting, then the mechanical relay in output “1” will open (“01” LED is now lit) cutting off power to the load. When the process temperature rises back above the limit setting, output “1” will remain open until you press the mode key to reset the controller.

Mode Key (Reset Button) — Operates as a reset button.

The Parameter Access Key — Used to index through parameters or to access menu levels.

Raise Key — Used to scroll up through available parameter settings, increase values or change menu levels (Hold for fast-step progression).

Lower Key — Used to scroll down through available parameter settings, decrease values or change menu levels (Hold for fast-step progression).

Limit Controller Option ED

Warning: Do not change the values in the CALL or CALH menu parameters. If this is done, the controller may need to be recalibrated.

Tech Tip: After setting up your controller, index through the entire menu system and write down the value or setting of each menu parameter. Keep this hard copy on hand in the event that an operator accidentally changes the values or settings. Then you can refer back to this list of settings and values to correctly set up the controller.

Operation (continued)

Quick Start Procedure

- 1) Apply power to the controller.
- 2) Press parameter access key to access the menu system.
- 3) Using the up/down arrow keys, select menu level “04”.
- 4) Press the parameter access key once until you reach the sensor type (IntP).
- 5) Select the sensor type that you will be using by pressing the up/down arrow keys (refer to parameter descriptions for menu “04” described earlier).
- 6) Press the parameter access key again to reach the limit type (LITP).
- 7) Using the up/down arrows keys, select High or Low limit.
- 8) Press the mode key to return to limit setting.
- 9) Set your limit to the desired value by pressing the up/down arrow keys.
- 10) To deny controller access through the front panel, press the parameter access key once, then using the up/down arrow keys, select menu level “00”. Press the mode key once. The controller is now in lockout mode. To regain controller access you must hold the parameter access key in for 11 seconds.

Digital Communications

Two communication options are available which allow interfacing to remote devices utilizing the most common industry standards, RS232 and RS485.

WARNING

Signal ground only. Grounding to frame may damage the controller and void warranty.

RS232

This method allows bidirectional data transfer via a three-conductor cable consisting of signal ground, receive input and transmit output. It is recommended for communication distances less than fifty feet between the computer terminal and the instrument. Note: Multiple instruments cannot be connected to the same port.

The RS232 port is optically isolated to eliminate ground loop problems. Typically, "Data Out" of the computer/terminal connects to the "RCV" terminal. "Data In" connects to the "XMT" terminal. If shielded cable is used, it should be connected to the frame ground at one end only. Signal ground is to be connected at appropriate ground terminals (refer to wiring diagram, page 51).

RS485

The RS485 multipoint capability allows up to 32 controllers to be connected together in a half-duplex network or up to 100 controllers with an appropriate communications repeater. This method allows bidirectional data transfer over a shielded twisted pair cable. The twisted pair cable is a transmission line; therefore, terminating resistors are required at the most distant ends of the line to minimize reflections (typically 60 ohms from each line to signal ground). The RS485 circuit is fully optically isolated, eliminating ground loop problems. Parallel drops from the transmission lines should be kept as

Digital Communications

Note: Call factory for a recommended RS485 converter.

short as possible; however, the line may be daisy-chained at each controller. The polarity of the line is important and each device will specify an "A" (+) and "B" (-) connection.

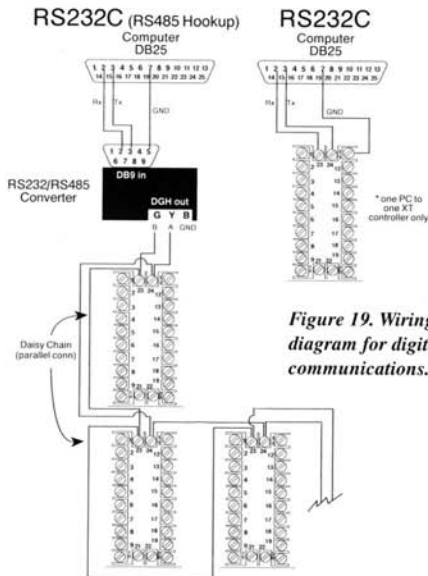

Figure 19. Wiring diagram for digital communications.

Digital Communications

**Table 1. Communications Parameter List
(Temperature Controller)**

Parameter No.	Description	Display	Minimum	Maximum
00	Process Value	nnnn	Sensor Dependent	
01	Setpoint	nnnn	Low Limit	High Limit
02	Access Code	Ac.Cd	00	05
03	Gain Output 1	Gn.o1	00	400
04	Gain Ratio 2	Gr.o2	0.0	2.0
05	Rate	rAtE	00	900
06	Reset	rSEt	00	3600
07	Heat Hysteresis	H.HYS	01	100
08	Cool Hysteresis	C.HYS	01	100
09	Cool Spread	C.SPPr	00	100
10	Damping	dPnG	OFF	High
11	Alarm 1	ALr1	Range Dependent	
12	Alarm 2	ALr2	Range Dependent	
13	Cycle Time 1	CY.t1	00	120
14	Cycle Time 2	CY.t2	00	120
15	Setpoint Target Time	Sp.tt	00 (OFF)	100
16	Low Setpoint Limit	L.SP.L	Sensor Dependent	
17	High Setpoint Limit	U.SP.L	Sensor Dependent	
18	Controller ID	Id.no	00	99
19	Baud Rate	bAUd	300	2400

**Table 2. Communications Parameter List
(Process Controller)**

Parameter No.	Description	Display	Minimum	Maximum
00	Process Value	nnnn	Low Scale	High Scale
01	Setpoint	nnnn	Low Scale	High Scale
02	Access Code	Ac.Cd	00	05

Digital Communications

03	Gain Output 1	Gn.o1	00	400
04	Gain Ratio 2	Gr.o2	0.0	2.0
05	Rate	rAtE	00	900
06	Reset	rSEt	00	3600
07	Hysteresis 1	HYS.1	01	100
08	Hysteresis 2	HYS.2	01	100
09	Spread 2	SPr.2	00	100
10	Damping	dPnG	00	Low/Normal/High
11	Alarm 1	ALr1	Low Scale	High Scale
12	Alarm 2	ALr2	Low Scale	High Scale
13	Cycle Time 1	CY.t1	00	120
14	Cycle Time 2	CY.t2	00	120
15	Setpoint Target Time	Sp.tt	00 (OFF)	100
16	Low Scale	L.SCL	-1999	9999
17	High Scale	H.SCL	-1999	9999
18	Controller ID	Id.no	00	99
19	Baud Rate	bAUd	300	2400

Table 3. Serial Communications Data Format

Baud Code	Baud Rate	Parity	Data Bits	Stop Bits
3.o.7	300	Odd	7	2
6.o.7	600	Odd	7	2
12.o.7	1200	Odd	7	2
24.o.7	2400	Odd	7	2
3.n.8	300	None	8	1
6.n.8	600	None	8	1
12.n.8	1200	None	8	1
24.n.8	2400	None	8	1

Interface Examples

This section describes the protocol for communication between the controller and either a video display terminal or computer (referred to below as "the host"). Message strings may be of two types — commands to controller or responses from controller.

General Comments

One host and multiple controllers may be interconnected on a single bus. The host may send commands to any controller and may receive responses from any controller. Each controller on the bus is assigned an identification code between 00 and 99. No two controllers on a given bus may have the same identification code. Controllers are not capable of communicating with other controllers.

Every valid message begins with a pound-sign (#) character.

Every valid message ends with a carriage-return (<CR>) character.

A valid message is composed of: Start Character, Controller ID Code, Command, Parameter, Data, Carriage-Return.

Every response begins with a line-feed (<LF>) character and ends with a carriage-return, line-feed pair (<CRLF>).

Caution:
Modifying parameter #19 (Baud Rate) by host may cause loss of data link.

Figure 20. General Communications Message Format

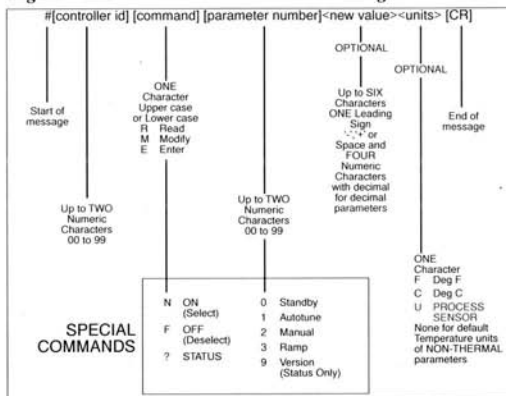

Example: For Standby "On", type #01N0[CR].

For proper digital communication with the controller(s), make the following checks:

- Baud rate of the controller(s) must match that of the computer or PLC device.
- Controller communication cable is connected to the correct serial port on your computer or PLC.
- Data TX and RX lines are going to the proper connector pins. If you are using RS422 line, short the RX+ and TX+ together ("A" signal) and the RX- and TX- together ("B" signal).

See wiring diagram, page 9.

Figure 21. Sample Communications Commands

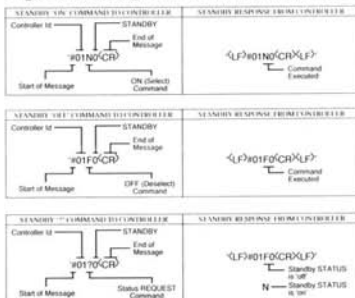
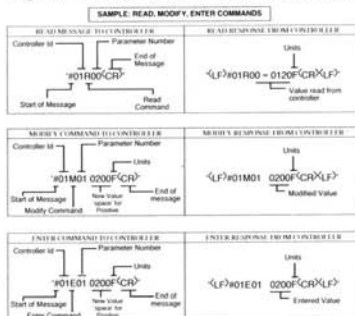

Figure 22. Requesting a Parameter from a Controller



On "Read Response" from controller using a decimal format, syntax will be as follows:
 Msg Sent: '#01R00<CR>'
 Msg Received:
 '<LF>#01R00 = -183.7F'

On "Modify" or "Enter" commands, do not use an equals sign (=); use a "space" instead.
 Ex. '#01M01 0200F<CR>'

Communications Notes







Caution:
 Wherever possible, avoid using the "Enter" command and use "Modify" instead. The "Enter" command makes permanent changes to the microprocessor, and after accepting a maximum capacity of 100,000 "Enter" statements, it will have to be returned to the factory and replaced.

1. The controller will respond with <LF>ERROR<CR><LF> for messages containing invalid/incorrect commands, parameter number or data (with decimal, if needed).
2. Process Value is a read-only parameter; therefore, a modify or enter command for Process Value will result in a <LF>ERROR<CR><LF> response.
3. For modify or enter command: if the new value is out of the parameter's range, the controller will default to the highest or lowest allowable parameter value.
4. Parameters with decimal data must contain a decimal character in the data portion of the message.
5. Ramp "on" command (Setpoint Target Time) will not be executed if ramp time is set to zero or absolute deviation between Setpoint and Process Value is less than 5 temperature or process units.
6. Autotune, manual and ramp commands are mutually exclusive, i.e., selecting manual while autotune is enabled will abort the autotune mode.
7. If the controller is in Standby mode, selecting autotune, manual or ramp will de-select Standby.
8. Setpoint should not be modified while the controller is in autotune or ramp mode.
9. The Setpoint Value enter command should not be executed while the controller is in manual mode.

Recalibration

Only qualified individuals utilizing the appropriate calibration equipment should attempt recalibration of the controller. For assistance, contact your Athena representative or call 1-800-782-6776.

Your controller has been calibrated at the factory, and need not be adjusted during the life of the controller unless sensor type is changed from thermocouple to RTD, or vice versa. In the event that recalibration is warranted, follow these procedures.

- 1) Access menu level "05" as previously instructed and select the sensor type.
- 2) Connect a calibrator with a range appropriate for the unit to be calibrated. Allow the controller to warm up for a minimum of 20 minutes. Set the range, and a low or zero value.
- 3) Access menu level "04" and then the Parameter/Access  key until [CAL.L] is displayed. Then, press the Raise  or Lower  key until the number in the controller's upper (PV) display window matches the indicated value of the calibration instrument.
- 4) Enter a value on the calibration instrument corresponding with the high-end value of the sensor range (span).
- 5) Again, in menu level "04", press the Parameter/Access  key until [CAL.H] is displayed. Then, press the Raise  or Lower  key until the number in the controller's upper (PV) display window matches the indicated value of the calibration instrument.
- 6) Repeat steps 3 through 5 until all readings agree.
- 7) Return the controller to regular operation by changing back to menu level "00" or "01" (if desired) and pressing the Mode  key.

Error Codes

Display	Problem	Action
[Err.H]	Open sensor	Check sensor and wiring Check type of sensor Recalibrate
[Err.L]	Reversed sensor	Check sensor and wiring Check type of sensor Recalibrate
[Err.O]	A/D error	Return to factory
[Err.J]	A/D error	Return to factory
---	Display out-of-range	Sensor over- or under-range
[LoAd no]	No control output	Call factory

Warranty/Repair Information

Two-Year Limited Warranty

Other than those expressly stated herein, THERE ARE NO OTHER WARRANTIES OF ANY KIND, EXPRESS OR IMPLIED, AND SPECIFICALLY EXCLUDED BUT NOT BY WAY OF LIMITATION, ARE THE IMPLIED WARRANTIES OF FITNESS FOR A PARTICULAR PURPOSE AND MERCHANTABILITY.

IT IS UNDERSTOOD AND AGREED THE SELLER'S LIABILITY WHETHER IN CONTRACT, IN TORT, UNDER ANY WARRANTY, IN NEGLIGENCE OR OTHERWISE SHALL NOT EXCEED THE RETURN OF THE AMOUNT OF THE PURCHASE PRICE PAID BY THE PURCHASER AND UNDER NO CIRCUMSTANCES SHALL SELLER BE LIABLE FOR SPECIAL, INDIRECT, INCIDENTAL OR CONSEQUENTIAL DAMAGES. THE PRICE STATED FOR THE EQUIPMENT IS A CONSIDERATION IN LIMITING SELLER'S LIABILITY. NO ACTION, REGARDLESS OF FORM, ARISING OUT OF THE TRANSACTIONS OF THIS AGREEMENT MAY BE BROUGHT BY PURCHASER MORE THAN ONE YEAR AFTER THE CAUSE OF ACTION HAS ACCRUED.

SELLER'S MAXIMUM LIABILITY SHALL NOT EXCEED AND BUYER'S REMEDY IS LIMITED TO EITHER (i) REPAIR OR REPLACEMENT OF THE DEFECTIVE PART OR PRODUCT, OR AT SELLER'S OPTION (ii) RETURN OF THE PRODUCT AND REFUND OF THE PURCHASE PRICE, AND SUCH REMEDY SHALL BE BUYER'S ENTIRE AND EXCLUSIVE REMEDY.

Warranty/Repair

Unit Repairs

It is recommended that units requiring service be returned to an authorized service center. Before a controller is returned for service, please consult the service center nearest you. In many cases, the problem can be cleared up over the telephone. When the unit needs to be returned, the service center will ask for a detailed explanation of problems encountered and a Purchase Order to cover any charge. This information should also be put in the box with the unit. This should expedite return of the unit to you.

This document is based on information available at the time of its publication. While efforts have been made to render accuracy to its content, the information contained herein does not cover all details or variations in hardware, nor does it provide for every possible contingency in connection with installation and maintenance. Features may be described herein which are not present in all hardware. Athena Controls assumes no obligation of notice to holders of this document with respect to changes subsequently made.

Proprietary information of Athena Controls, Inc. is furnished for customer use only. No other use is authorized without the written permission of Athena Controls, Inc.

Technical Specifications

Performance

Accuracy	±0.2% of full scale, ± one digit
Setpoint Accuracy	1 degree/0.1 degree
Temperature Stability	5 μ V/ $^{\circ}$ C max; 3 μ V/ $^{\circ}$ C typical
TC Cold End Tracking	0.05 $^{\circ}$ C ambient
Noise Rejection	Common mode >100 dB Series Mode >70 dB
Process Sampling Rate	10 Hz (100 ms)

Inputs

Thermocouple	K, J, N, R, T, S, Maximum lead resistance 100 ohms for rated accuracy
RTD	Platinum 2- and 3-wire, 100 ohms at 0 $^{\circ}$ C, DIN curve standard (0.00385)
Linear	0-50 mV/10-50 mV, 0-5 V/1-5 V/ 0-10 V/2-10 V, 0-20 mA/4-20 mA

Input Impedances

0-50 mV/10-50 mV:	>1 M ohm \pm 1%
0-5/1-5 V:	12.5 K ohm \pm 1%
0-20 mA/4-20 mA:	250 ohm \pm 1%
0-10 V/2-10 V:	200 K ohm

Technical Specifications

Outputs

#1	Reverse acting (heating)
#2	Direct acting (cooling)
B	Relay, 5 A @ 120 Vac resistive 3 A @ 240 Vac
E	0-20 mAdc, 500 ohm max.
F	4-20 mAdc, 500 ohm max.
S	20 Vdc pulsed
T	Solid-state relay, 120/240 Vac, zero voltage-switched, 1 A continuous, 10 A surge @ 25 $^{\circ}$ C

Alarms

B	Electromechanical relay, 5 A @ 120 Vac, 3 A @ 240 Vac
T	Solid-state relay, 120/240 Vac, zero voltage-switched, 1 A continuous, 10 A surge @ 25 $^{\circ}$ C

Control Characteristics

Setpoint Limits	Limited to configured range
Alarms	Adjustable for high/low; selectable process or deviation
Rate	0 to 900 seconds
Reset	0 to 3600 seconds
Cycle Time	0.2 (zero setting) to 120 seconds
Gain	0 to 400
Gain Ratio	0 to 2.0 (in 0.1 increments)
Control Hysteresis	1 to 100 units (on/off configuration)
Cool Spread, Output 2	0 to 100 $^{\circ}$ F/C above setpoint (Temp.)
Spread 2, Output 2	0 to 100 units above setpoint (Process)

Technical Specifications

Damping
Setpoint Target Time
(Ramp-to-Setpoint)
Autotune
Manual

Selectable (low, normal, high, off)
0 (off) to 100 minutes

Operator-initiated
Operator-initiated

General

Line Voltage

115 to 230 V $\pm 10\%$, 50-60 Hz
130 to 300 Vdc $\pm 10\%$ (Auto-Polarity)

Display

18 and 19

Dual, 4-digit 0.36" (9.2 mm) LED display
Process Value: Orange
Menu/Parameter Value: Green

25

Dual, 4-digit LED display
Process Value: 0.55" (14.0 mm), Orange
Menu/Parameter Value: 0.36" (9.2 mm), Green

Power Consumption

Less than 6 VA (@ 120/240 Vac)

Panel Cutout

18

1.772" W x 3.622" H (45 mm x 92 mm)

19

3.622" W x 1.772" H (92 mm x 45 mm)

25

3.622" W x 3.622" H (92 mm x 92 mm)

Depth Behind Panel

3.937" (100 mm)

Front Panel Rating

NEMA 4X

Operating Temperature

32 to 131° F (0 to 55° C)

Humidity Conditions

90% R.H. max., non-condensing

Parameter Retention

Solid-state, non-volatile memory

Connections

Input and output via barrier strip with locking terminals

Contacts

Twinned bifurcated

Ordering Codes

Model

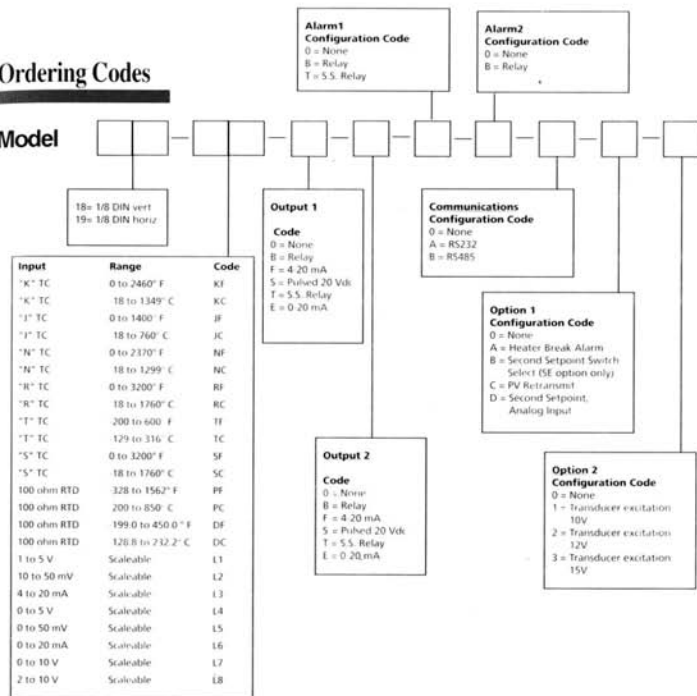

Quick Setup Instructions - 18/19/25 Temperature Controller

Experienced users, already familiar with mounting and wiring the Series 18/19/25 may use these condensed instructions to autotune the controller and get started quickly.



These quick setup instructions are not meant as a substitute for reading the full instruction manual. Please be sure to read through the manual for specific details of operation and, most importantly, for safety precautions. If you have questions, or experience problems with setting up your controller, consult the full instruction manual first and, if you still need assistance, contact your Athena representative or call 1-800-782-6776.



- Apply power. After self-check display stops, immediately place the controller into Standby mode by pressing and holding the **Mode** key for four seconds until [StbY] flashes.
 - Press **Access** key until [Ac.Cd.] flashes. (This can take anywhere from one to eleven seconds, depending on the menu level at which the controller is currently set.)
 - If the controller is not at menu level "05", press **Raise** or **Lower** until "05" appears.
 - Press **Access** until [SnSr] flashes. Then use **Raise** or **Lower** to select Sensor Type.
- NOTE: Unless otherwise instructed, the following steps require that you first press the Parameter/Access key, and then the Raise or Lower key to select the appropriate parameter value.**
- Select Heating Mode on Output 1 [OUT 1].
[Ht.P] = PID [Ht.O] = On/Off
Repeat for Cooling Mode on Output 2 [OUT 2].
[CL.P] = PID [CL.O] = On/Off
- Important: If only one output is PID, set the other output to On/Off.**
- Select Cooling Type [CoL.t].
[nor] = standard/no cooling [H2o] = water-cooled extruders
 - Select Alarm [Al.H.L.], either [HI] or [Lo].
 - Select Alarm Type [A1.P.d.], either Process [Pr] or Deviation [dE].
- Select Alarm Operation [Al.O.P.], either Normal [nor], Latching [LAt] or Off [OFF].
 - Repeat Steps 7 through 9 for Alarm 2, if applicable.
 - Select Temperature Units [Unit], either [F] or [C], then press **Mode** key once to display setpoint. Use **Raise** or **Lower** keys to select Setpoint Value.
 - Press **Access** key once to return controller to [Ac.Cd] display.
 - Press **Lower** key twice to select menu level "03".
 - Select Alarm Trip Points [ALr1] and/or [ALR2], if applicable. Note: This menu parameter will not appear if Alarm Operation (Step #9) is set to [OFF].
 - Select Cycle Times [CY.t1] and/or [CY.t2] as follows:

For Control Output Type —	Select Cycle Time (in seconds)
B	15
E	00
F	00
S	00
T	15
 - Scroll to Setpoint Target Time [SP.tt] and set to [OFF].
 - Select Lower Setpoint Limit [L.SPL] and Upper Setpoint Limit [U.SPL] to the desired value.
 - Press **Mode** key once, then **Access** key once to restore [Ac.Cd] display. Change to menu level "02".
 - Use the **Access** key to scroll through to the Damping menu parameter [dPnG]. Select normal [nL].
Note: If your process is subject to thermal lag, (see page 28)
 - Press and hold the **Mode** key until [tUnE] appears. When the display stops flashing [tUnE], the controller is tuned. For safety and security purposes, you may want to change to key-lockout menu level "00" or Limited Access Run menu level "01" before beginning your process operations.



Keep This Card in a Safe Place

Configured Parameters Reference Card

Series 16/18/19/25 Temperature Controllers

Model Number _____

Zone Location _____

Firmware Version No. _____

(Displayed when the controller is powered up after all the segments on both lines of the display have been tested).

Dear Customer:

Please keep this card handy – in case your controller should lose its configured initial parameter values or for easy reference when setting up a new controller. After auto-tuning, and when your controller is controlling well, we suggest you write the displayed value for each of the menu parameters listed on the other side of this card. If you do not use a listed parameter, indicate "N/A". Using this card to document your parameter settings could reduce your downtime. If you have any questions, or need further assistance, please contact Athena Controls Technical Support:

Toll-free (in U.S.): 800.782.6776

Telephone: 610.828.2490

Fax: 610.828.7084

E-Mail: sales@athenacontrols.com

www.athenacontrols.com

Configured Parameters Reference Card

Series 16/18/19/25 Temperature Controllers

Menu 2

Gn.O1 _____

Gn.O2 _____

rAtE _____

rSEt _____

dPnG _____

H.HYS _____

C.HYS _____

C.SPc _____

Menu 3

R1r1 _____

R1r2 _____

CYt1 _____

CYt2 _____

SP.tt _____

L.SP.L _____

U.SP.L _____

Menu 4

Id.no _____

bAUd _____

Menu 5

SnSr _____

FILt _____

OUt1 _____

OUt2 _____

CoL.t _____

R1.HL _____

R1.Pd _____

R1.OP _____

R2.HL _____

R2.Pd _____

R2.OF _____

U.t _____

***For Technical Assistance in the U.S.,
Call Toll Free: 1-800-782-6776
E-Mail: techsupport@athenacontrols.com***



CORPORATE HEADQUARTERS

Athena Controls, Inc.

5145 Campus Drive

Plymouth Meeting, PA 19462 U.S.A.

Tel: (610) 828-2490

Fax: (610) 828-7084

Toll-Free in U.S.: 1-800-782-6776

Internet: www.athenacontrols.com

E-Mail: techsupport@athenacontrols.com